



ANCHORING PRACTICE

By: Capt. Jerzy T. Idzikowski BSc, Master Mariner



Copyright © Capt. Jerzy T. Idzikowski, 2001

**Atlantic Ocean, Parana River, June - August 2001
M/V "Rixta Oldendorff"**

PLANNING

Before arrival to the harbour limits and its roads the master should consult all available to him on board publications in order to get **necessary environmental information**.

The most important are:

- a) Location of an anchorage designed for our vessel.
- b) Depth at this anchorage (for many ships, especially large vessels absolute maximum is the depth less than 82 metres!),
- c) Type of the sea bed (the rock and coral are not suitable),
- d) Direction and strength of current during planned time of approach to an anchorage, and during next few days, if stay at anchor will be longer,
- e) Weather forecast for particular area (wind direction and strength, visibility, state of the sea, etc.),
- f) Availability of adequate sea room, particularly to seaward,
- g) Adequate safety distance to the nearest fairway,
- h) The best, safety route to this anchorage.
- i) Distance from the chosen anchoring place to the nearest grounding line (should be not less, than 1 Nm!),
- j) Is there enough sea room to turn the vessel of 180° / 360°?

Decision about which anchor will be used, the necessary scope of anchor cable finally paid off, and method of anchoring depends mainly on all available data.

The excellent indication of the direction in which is setting current / or average force of the current and wind at an anchorage is heading of anchored vessels, but such information is available to us only shortly before arrival.

We have to remember, that:

- 1 knot of current = 6° B (mean 24 knots of wind), if acting on loaded general cargo vessel. If fully loaded large tanker or bulk carrier is taken under consideration the ratio is even higher. We should keep in mind that a 30 knots wind exerts the same force on an equal area as a 1-knot current.
- The heading of the anchored vessels in ballast may be quite different from the heading of fully loaded ships.

The minimal safety ship's under keel clearance when anchor is used.

In order to avoid damage to the underwater hull shell plates it is recommended (of course if practicable) to have **under keel clearance of amount at least 20% of maximum vessel's draft in loaded condition**.

But this is applying to the calm weather condition and smooth seas only.

In the case of rough seas, and vessel's rolling additional allowance should include provision for following:

- a) Half of the expected height of the maximum expected wave,
- b) Increase of draft due to list or heel

Formula:

Increase in Draft = Draft x cos Heel + (Beam x sin Heel)/2 - Draft

simplified formula:

Increase of Draft = Half Beam x sin Angle of Heel

As very useful, and easy to remember:

For every 1 degree of roll increase of draft in centimetres is equal to vessel's beam in metres.

E.g. for "Panamax" vessel with beam of 32 m, can expect to increase her draft by about 30 cm (0.3 m) for every 1° of roll.

Which anchor to use?

- In the old seamanship textbooks was written that **portside anchor is the anchor of northern hemisphere, and starboard side one is southern hemisphere**. This is correct in temperate zones / latitudes, due to facts that lows are passing mostly north of vessel position in northern hemisphere, and vice versa, regarding southern hemisphere (we can say: between vessel and the Poles).

Let analyse the figure No 1. Northern hemisphere.

Vessel is anchored at port side anchor southeast of the centre of forthcoming depression. As winds blow anticlockwise around the centre of low pressure the most common wind sequence experienced is southwesterly ahead of warm front, veering westerly in the warm-sector and finally veering northwesterly at the cold front. If this is necessary to drop the second anchor, in this case from the starboard side the cables are not fouled because vessel's swing is clockwise.

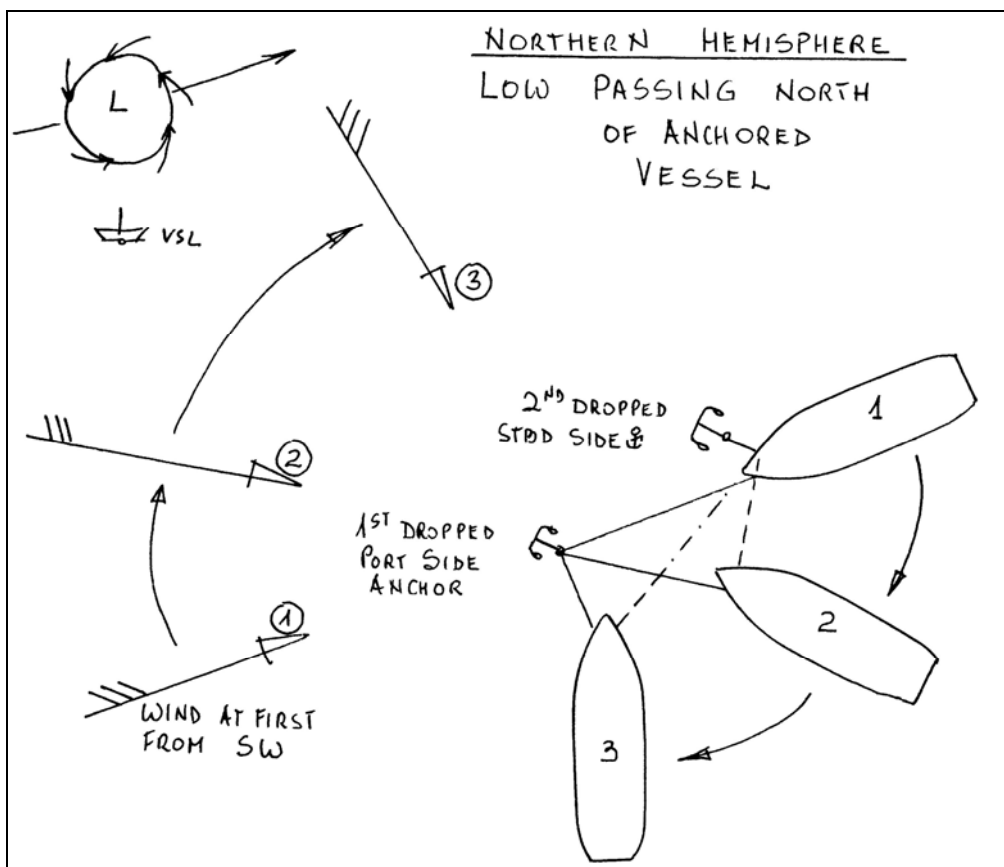

Figure 1. Port side anchor – “Northern hemisphere anchor”

- From this old rule we are learnt, that if dropping the second anchor is planned ship's relative position to the expected depression should be taken under consideration in order do not foul the anchor cables during changes of wind direction.
- Some masters prefer to drop this anchor, which cable is stronger and in better condition, it means situation depends on the particular vessel.
- Anyway this is good seamanship practice to have ready to let go both anchors and observe vessels anchored close to planned anchor position. If anchor is dropped from same side, as it was seen on ships anchored around, there is higher probability of swinging the vessel in same direction as others. This is very important during wind / tide direction changes at such congested anchorages as Singapore or Suez Roads, where ships are anchored in distance of three cables only. If direction of swing and rate of turn are different on vessels close anchored their sterns may come close each other. In such situation it was observed decrease of distance between ships' sterns up to one cable, or even less, what is dangerous, and absolutely not acceptable practice.

What ship's speed over the ground when the anchor is let go, or whilst the cable is paid out is allowed?

The speed over the ground of the vessel dropping the anchor, or when the cable is paid out, needs to be minimized. This requirement is more critical for large vessels, worsening with weather conditions and decreasing the water depth.

For a VLCC the permissible speed is, depends on the sources from 0,25 to 0,5 knots only.

For smaller vessel speed should be not higher then 2 knots (under normal circumstances).

To determinate such low speed over the ground with necessary accuracy is very difficult, if even impossible.

It was observed, that when speed dropped to about 0.5 knot, GPS shows movement of the antenna, therefore aboard ships with superstructure aft, the stern of the vessel.

This is completely useless for anchoring purposes.

Aboard large vessels this is suggested by experienced ship handlers to start walk out the anchor when speed is of two knots. When the ship is stopped anchor should just touch the seabed. When the cable starts to lead in the desired direction is letting go, or walked back to the required amount of shackles.

This method will be described in details later.

How many shackles of anchor cable to use?

The amount of anchor cable used will depend upon:

- The depth of water at anchorage,
- Ship's draft,
- Environmental conditions such wind direction and force, current setting, rate, type of bottom, state of sea,
- Time that the vessel is expected at the anchor,
- Distance to the nearest ships already anchored.

The most popular rules regarding the amount of anchor cable are as follows:

1. As very rough guide we can say **3.5 to 4 times the depth. Five times if possible.**
2. Another rule says that the length of mild steel cable to use in metres may be taken as approximately 25 times the square root of the depth of water given in metres too.
Length in metres: $L = 25 \times \sqrt{\text{depth}}$
Length in shackles = $L/27.5$
3.

Below 20 m	6 to 8 shackles
20 to 40 m	4 to 6 shackles
Over 40 m	less than 4 shackles

Under normal circumstances (depth up to 30 metres) I do not use less than 5 shackles, and this comply with above-mentioned rules.

Main exception are congested anchorages as for example Singapore Roads, where for handy size vessel 3 shackles in the water, and for “Panamax” – 4 shackles in the water only must be accepted.

To drop the anchor on let go, or walk back (out)? Class limitations. Safety precautions.

This decision depends basically on the depth of the water available, and kind of bottom.

- In the shallow waters, **up to the depth of 30 metres**, with the soft bottom (mud), customary practice is letting go the anchor from the hawse pipe.
- According to my sea experience I prefer to let go the anchor just from the hawse pipe only when depth of water does not exceed about 20 metres.
- Therefore if depth is **between 20 and 30 metres**, the anchor is at first walked out (back) until the shank is fully submerged and crown shackle seen only. The brake is applied and windlass gear disengaged. Now the anchor is allowed freely let go. Submerge of anchor apparently lessening the weight of anchor (buoyancy force is acting!). The distance to the bottom is decreased, what is of significance, especially when ship is in ballast condition, and hawse pipes are far away from the water level. In this method anchor will not gain too much momentum making it difficult to check with brake.
- If the depth is **more than 30, but less than 60 metres**, the anchor cable should be walked out until the anchor is within the depth, just touches the ground, or let say few metres above the bottom (but not more than ten). This is recommended as the means of restricting the velocities and loads in the anchoring system.
- In depths **over 60 metres** the windlass should be kept in the gear and cable walked out to the length required. Attention must be given to restricting the walkout speed so damage to the windlass gear and motor are avoided. **If necessary the brake and cable stopper should be applied immediately, because as per class rules windlass brake is 12 times more powerful than the motor, and cable stopper, so-called pawl, or “guillotine stopper” has twice the holding power of the brake and is the strongest link in all anchoring system.**

- **If the depth is more than 82 metres (3 shackles only!) this is the class limit**, and absolute maximum very important for large ships, equipped with anchors of weight between 11 tons (“Panamax”) up to 35 tons (VLLC tankers). Check what is the class limit for your vessel. Almost all vessels are designed to the 82-metre rule. This rule says, that windlass motor should be capable to lift three shackles of 15 fathoms (27.5 m) length of cable plus the anchor, ***but up and down!*** There is an allowance of 50% over this for safety purposes on test, but not for in-service use.

Anchor holding power

Anchors of merchant ships can roughly be classified in two categories:

- A) Normal stockless anchors and
- B) High holding-power (HHP) anchors.

The anchor's holding power depends on:

- Weight,
- Type,
- Bottom characteristics (holding ground);

There is an additional effect of chain length used on the anchor holding power.

This additional effect is taking into account

- Weight of chain,
- Water depth,
- Height of hawse pipe
- Bottom characteristics.

As an indication of the holding power of an anchor, the following multiplication factors may be used for the above-mentioned class “A” anchors:

Sand and hard clay 4 - 6 x anchor weight

Mud and medium clay 3 - 5 x anchor weight

Soft mud and soft clay 2 - 3 x anchor weight

For class “B” anchors these multiplication factors may be doubled.

As mentioned above, the part of the chain lying on the seabed is added to the anchor's holding power. On the other hand, when the anchor chain length is such that the force direction on the anchor is oriented under an angle with the seabed, in other words when the anchor shaft makes an angle with the seabed, the holding power of the anchor is reduced. **When the shaft is lifted of 5°, the loss of holding power is 25%, and at 15° the loss of power is about 50%.**

PREPARATION

AS REMINDER ONLY:

This is really good practice to stop the vessel enough early before arrival anchorage. Testing the main engine astern and emergency steering gear are fruitful. In case of any problems, vessel may drift safely in open waters when crew is carry out necessary repairs.

According to International, and U.S. Coastguard requirements, and good sea practice as well, not more then 12 hours before entering on the navigable waters the following equipment has to be tested:

- 1. Primary and secondary steering gear. In the test procedure must be included: a visual inspection of the steering gear and its connecting linkage, and the operation of the following:**
 - a) each remote steering gear control system,
 - b) each steering position located on the navigating bridge,
 - c) the main steering gear from the alternative power supply,
 - d) each rudder angle indicator in relation to the actual position of the rudder,
 - e) each remote steering gear control system power failure alarm,
 - f) each remote steering gear power unit failure alarm,
 - g) the full movement of the rudder to the required capabilities of the steering gear,
- 2. All internal vessel control communications and vessel control alarms.**
- 3. Standby or emergency generator (for as long as necessary to show proper functioning, including steady state temperature and pressure readings).**
- 4. Storage batteries for emergency lighting and power systems in vessel control and propulsion machinery spaces.**
- 5. Main propulsion machinery, ahead and astern.**

—

Coming to an anchorage from the open sea the Officer On Watch (OOW) has to inform the Engineer On Watch (EOW), and the Chief Engineer as well, enough early about time of arrival.

As normal established practice is to inform the engineers minimum one hour before, and aboard vessels with engines operated during manoeuvres on diesel or gas oil, even little a bit more, let say 1 hour 15 minutes before planned arrival the outer limit of anchorage.

One hour is needed for engineers to reduce main engine revolutions to manoeuvring RPM and / or change fuel from IFO to MDO.

The additional 15 minutes is the necessary minimum for the Master to reduce the speed and make slow headway over the ground when approaching an anchorage. Mentioned time depends on the Master, but seems useless, and not professional to come in an anchorage at dead slow ahead few hours.

The both anchors should be prepared for immediate use not later, than about one hour before approaching the anchorage.

The proper preparation of anchors consists:

- a) Taking off the tarpaulin /steel / concrete (if any) covers into the chains lockers,
- b) Taking off the additional lashing wires / chains,

- c) Putting the windlass in the gear,
- d) Disengage of the pawl (“guillotine”) stoppers by taking them off,
- e) Release the windlass brake,
- f) Lowering (walking out) by the gear both anchors clear of the hawse pipes for about 30 – 50 cm in order to be sure anchors are not stacked up / blocked in the hawse pipes and can be letting go without unnecessary delay. This is very important especially for deep loaded vessels having encountered heavy weather conditions underway from the last port of call.
- g) Then the brakes are screwed well up and the windlass taken out of the gear, both anchors ready for letting go.
- h) The anchor ball and lights prepared / checked in order to display them as soon as the anchor is dropped. The good sea practice shows, that even during daytime in good visibility the anchor’s light should be switched on (always keep in mind, that the visibility at sea may be deteriorated in short period of time).

Because much depends on good communications between the bridge and forward station all available means should be checked. The batteries of hand held radiotelephones (“Walkie-Talkies”) must be fully charged well before arrival. Radio check has to be carried out to full satisfaction of all parties.



Fig. 2. Both anchors ready to use

REDUCTION OF SPEED - METHODS

The second stage of this manoeuvre is efficient reduction of speed to such amount, that we have full control on vessel's behaviour.

Main available methods of controlled reduction ship's speed are:

1. **By the Modified "Inertia Stop"**.
2. **By the Progressive Reduction of Speed by Propeller at Steady Course.**
3. **By Turning the Vessel of 360°.**
4. **By carry out the "U-Turn" (turning the vessel of about 180°).**
5. **By carry out the Modified "U-Turn"**
6. **"Rudder Cycling", or "Fish Tailing".**

By the Modified "Inertia Stop". The pure "Inertia Stop" means main engine/s is/are stopped, vessel is moving ahead, and the way is taken off without putting the main engine/s astern, by water resistance only. This method takes plenty of time and stopping distance is equal to 8 up to 15 lengths of vessel, depends on the type and size of the ship. With the slow speed in the last part of this manoeuvre vessel is sluggish and difficult to keep at the desired course. In the modified "Inertia Stop" the main engine working astern when speed is about 4 knots stops vessel. However stopping distance is less than before, but takes plenty of time too, and therefore is not advisable, apart of fact, that few hours would stretch anyone's patience, even the angel!

By Progressive Reduction of Speed by Propeller at Steady Course.

RPM of main engine are reduced step by step from Full Ahead, through Half Ahead, Slow Ahead, Dead Slow Ahead, Stop and appropriate astern revolutions up to even completely stopping the vessel over the ground if necessary. So-called "Slow Speed Control" should be applied in the last phase of this manoeuvre in order to keep the vessel's heading as required. If the ship's speed is too slow, and she does not answer the helm, the control should be achieved again by applying rudder 20° or even hard over, and "kick ahead" (a short but substantial burst of main engine power).

Also this method takes time, and requires long distance. By the way this is noteworthy that on a vessel moving at full speed, a propeller working at 20% of its capacity meets more resistance of the water than does a stopped propeller. Other words ordering Dead Slow on the engine, after the vessel made full speed ahead, gives better braking effect, than immediately stopping the propeller.

By Turning the Vessel of 360°. This method is most desperate, but also most effective. Let us know about advantages, disadvantages and limitations of this method.

At first all vessels around are confused, particularly these under way, if not appropriate advised about our intentions.

This is well known, that ship's speed during normal turn, with rudder put hard over is reduced, depends on the type of vessel - from 30 to 50% of the initial.

The explanation is simple: she is sliding sideways and ahead and the exposed side area giving additional increase in water resistance, which in turn acts as a brake.

The fully bodied vessels, such as bulk carriers and tankers have experienced larger reduction of speed than ships of more fine underwater body, with higher ratio L/B (length between perpendiculars to beam).

The long bulbous bow fully submerged, even keel, or trim by head is giving the pivot point farther forward, and consequently smaller turning circle and a larger loss of initial speed.

To use of this method it is necessary to provide sufficient sea room.

In deep water the diameter of turning circle for underpowered vessels, as are bulk carriers and tankers vary between 3.2 and 3.8 times ship's length. For example 250 KDWT tanker of LBP 329.2 m has turning circle diameter $3.4 \times L =$ about 1120 m. It gives us 0.604 Nm, other words 6 cables only. We can say we are able to turn around such large vessels, and slow her speed up to 4.5-6 knots at distance of about one Nautical Mile, including the safety margin. This is really impressive achievement! But we have to keep in mind that in most port approaches should be expected shallow water effect, and it means the turning circle of our vessel may be even twice larger than in the deep water, and behaviour of ship surprisingly different, especially if approaching speed is excessive.

Conclusion: if this method of speed reduction is planned, should be carried out in right distance (including the safety margin) from the nearest vessels / shallow waters. In the example mentioned above simple calculations show us, that at distance of two nautical miles we are able to swing the vessel and drop down the speed to reasonable safety, fully controlled amount, therefore if such manoeuvre is carried out at distance let say 5 Nm from the anchorage – this is safety, and under control.

Of course for smaller vessels required safety distance is adequate smaller.

By carrying out of the “U-Turn” (turning the vessel of about 180°).

This is very effective method and used directly before dropping the anchor.

It consists elements of both methods: The Progressive Reduction of Speed by Propeller at Steady Course and The Turning Vessel of 360°.

We have to approach at 180° to the final heading at anchor, and therefore there is most convenient situation when the wind and current are following us (setting onshore).

The approach speed should be suitable for the searoom and ships' traffic. At first stage ship's speed reduction is progressive by propeller only, up to let say 4-6 knots, and depends mostly on type and size of the vessel, her draft and trim, manoeuvring characteristic, available searoom, wind, and current strength.

The typical “U-turn” starts the swinging just when ship's bow is abeam of the planned bow final position. The rudder is put hard over towards the side where is desired anchoring position, main engine at Dead Slow Ahead. Once the turn is started, engine is stopped. There is used anchor on the inside of the turn. When the vessel is canted of about 135° she should be at very slow speed, and easily stopped by Slow Astern applied only. In order to come exactly at planned anchoring position very good knowledge and experience of particular ship's behaviour in different conditions is required, otherwise real position may vary from chosen previously.

By carrying out the Modified “U-Turn”.

The main differences to the classic “U-Turn” are:

- The commencement of turning the vessel is little a bit delayed.
- The main engine is kept at Dead Slow Ahead longer, up to reaching heading different of about 135° from initial.
- Additional distance achieved by delayed swing is used to make necessary corrections in course and speed of approach, in order to drop the anchor exactly in the planned position.

- Keeping Dead Slow Ahead longer allows ship faster answering the helm and master better “feeling the vessel”.

“Rudder Cycling”, or “Fish Tailing”.

This method is based on observation, that vessel with rudder put hard over is losing her initial speed before the turn has well set in, that is, between 10 and 90 degrees of turn. In a later stage of the full turn speed is constant.

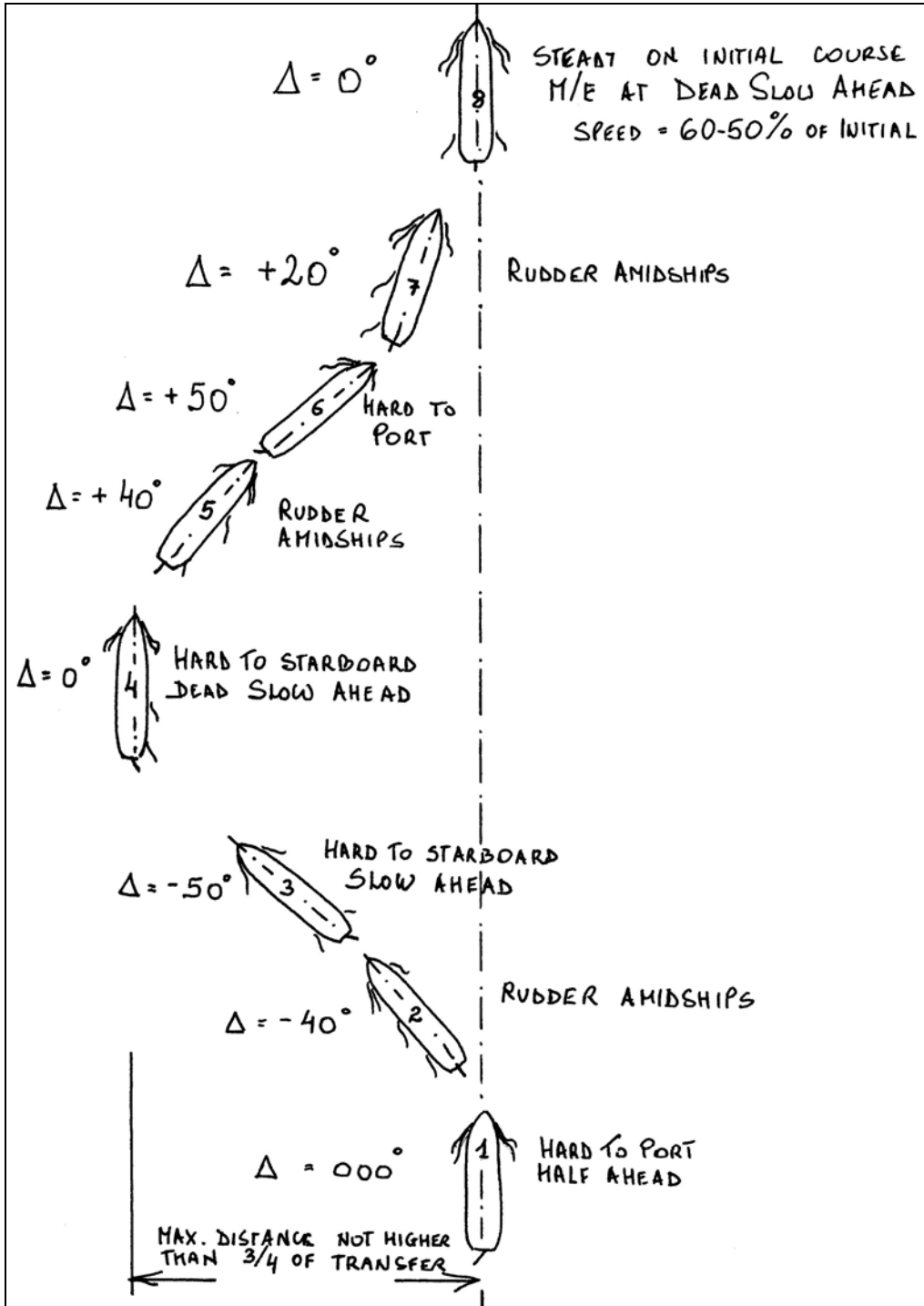

Figure 3. Rudder Cycling” or “Fish Tailing”

This method is similar to zigzag made by skier going downhill, in both cases larger changes from the original heading slowing down the speed.

If everything is going well in the distance of about 4 Nm to the anchorage limit (or to the first anchored vessel) EOW or C/E should inform us, that M/E is ready to manoeuvres (at manoeuvring RPM).

In the distance reduced to 4 – 3 Nm the rudder is put hard over, let say Hard to Port, and main engine revolutions reduced to Half Ahead.

When the heading is altered of about minus 40° from the initial next order for helmsman is “Rudder Midships!”

“Hard to Starboard” is ordered having the rudder amidship. Most probably that time heading of our vessel will differ of about minus 50° from the initial.

Same time the engine telegraph should be put at Slow Ahead.

As the ship’s head will reach the initial course with rudder still Hard to Port main engine RPM are reduced to Dead Slow Ahead.

If heading is changed plus 40° from the initial the rudder is put amidships, and as soon reaches “zero” position “Hard to Port!” is ordered again. That time difference in courses is most probably plus 50°.

As soon as ship’s heading is plus 20° from initial the rudder is put amidships.

Due to momentum of rotation the vessel is coming to initial course. Even with revolutions of M/E kept at Dead Slow Ahead continuously the speed should be reduced up to 50 –60% of speed before this manoeuvre. Of course it depends on the vessel.

In major cases speed should be about 4.5 - 6 knots, what is fully controlled, and acceptable.

If we are still not satisfied with speed this manoeuvre may be once or twice repeated. Meantime our distance to the anchorage limit, or nearest anchored vessel should be reduced not more than to one and half of nautical mile.

In the emergency we are able to swing the vessel around, or to stop at distance less, than one mile, even with the main engine put at Slow Astern only.

There are many variation of “Rudder Cycling” manoeuvre.

Some captains prefer smaller amount of heading alternation, but more often.

Anyway every prudent master should carry out this manoeuvre at first far away from the shallow water and ship’s traffic.

Ship’s behaviour should be well known to the ship handler before arrival any anchorage, or congested waters.

General remarks regarding reduction of speed:

- The choice of method depends mostly on the ship handler, his knowledge and practical experience in ship handling, “feeling” behaviour of particular vessel, and familiarization with the anchorage and local waters.
- “U-Turn” and “Modified U-Turn” are used directly before dropping the anchor, therefore if anchorage is congested main reduction of speed, let say up to Half or Slow Ahead should be carried out by other methods.
- There is freedom in application of methods, separate or combined.
- “The Rudder Cycling” at the beginning, together with “Modified U-Turn” in the second stage of this manoeuvre is in my opinion the best, fully acceptable, safety, enough fast and effective.

APPROACHING AN ANCHORAGE

Assume, approach speed has been reduced earlier to amount fully controlled, and vessel is arriving an anchorage with bare, required by circumstances steerage way.

Whenever it is possible and applicable one deck officer should be with master on the bridge to plot the ship's position.

Vessel's position should be determined by independent means, as terrestrial bearings, radar distances and GPS, and plotted at sufficiently frequent intervals (even few minutes close to planned anchor position). Parallel index techniques can be very useful when monitoring the ship's progress.

There are such practical anchoring cases:

1. Open anchorage, and anchored vessels are heading towards the open sea.
2. Open anchorage, anchored vessel are heading towards the shore.
3. Open anchorage, anchored vessels are heading parallel to the coastline.
4. Open anchorage, no anchored vessels in sight.
5. Enclosed congested anchorage, within harbour limits, confined to a specific location.

1. Open anchorage, and anchored vessels are heading towards the open sea.

By means of radar and binocular most suitable position between the anchored vessels is searched. The minimal distance to other ships when the anchor is already brought up should be not less than 5 cables.

Distance to the nearest shoreline, shallow water or isolated danger should be, if possible higher than 1 nautical mile.

This is absolutely necessary to keep crew (anchor party) ready at fo'c'sle enough earlier before coming between the anchored vessels. The best helmsman should be chosen.

This approach is illustrated in fig. 4

Due to higher rate of drift, setting by current, slow speed, wider drift angle in turn **THIS IS DANGEROUS AND FORBIDDEN** to pass close ahead of anchored vessels. Such situation in fig. 4 is marked "NEVER!"

Instead of such risky manoeuvre, approaching vessel should pass behind the stern of ship "B". It gives her more room to adjust final approach heading and speed.

This is the ideal situation to use "Modified U-Turn" method.

In order to place vessel exactly in middle between the ships anchored forward and aft of planned anchoring position the allowance of **1 up to 2 cables** for the cable length and possible dragging, until she will be brought up is advised, it means that ship's position in moment of dropping the anchor should be closer to windward vessel of mentioned earlier allowance.

This is self-explanatory in figure 4.

Dead slow ahead should be kept until reaching position 4.
 In many cases "kicks ahead" are needed to initiate required change of heading.

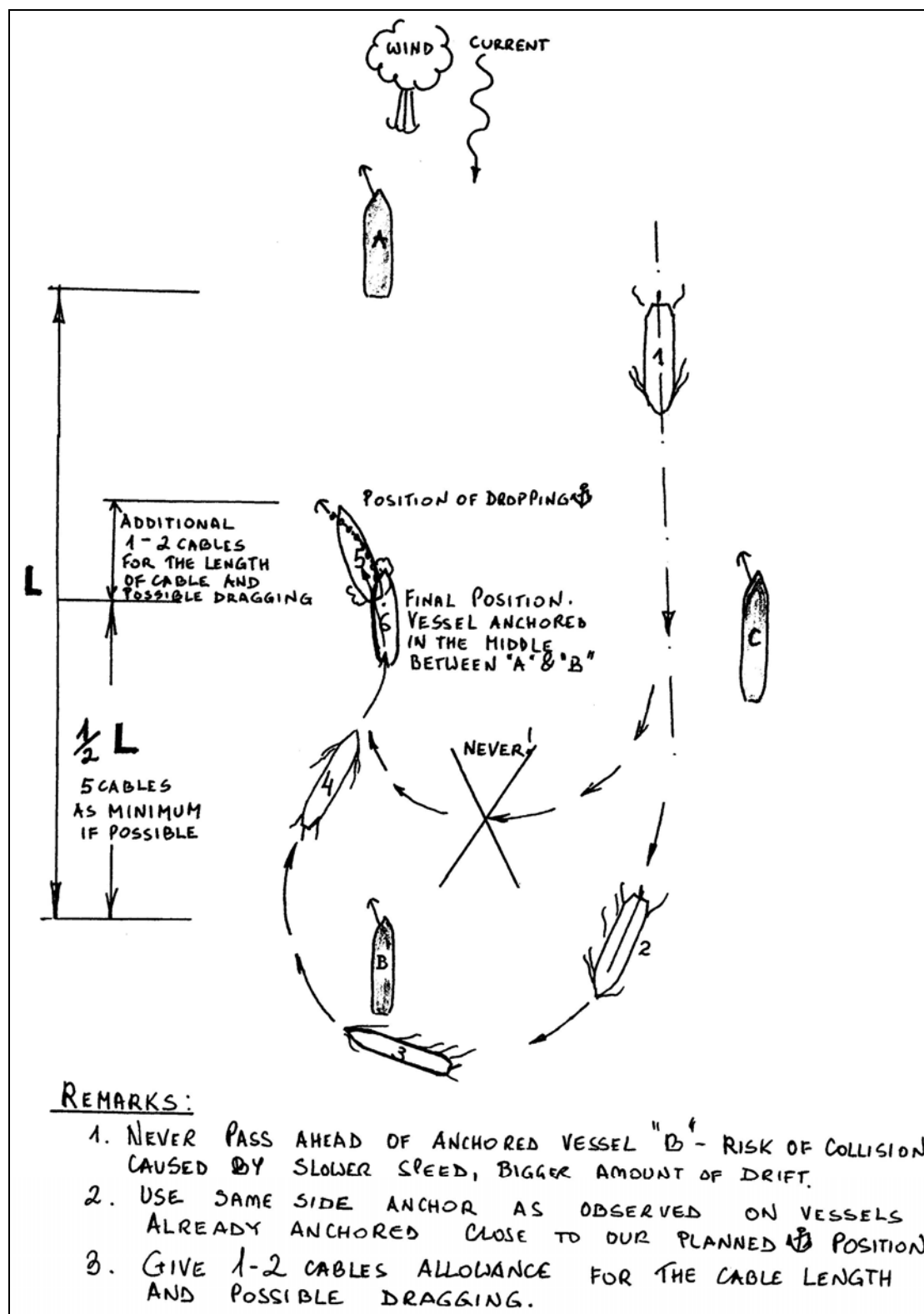

Figure 4. Safety approach to planned anchor dropping position

2. Open anchorage, anchored vessels are heading towards the shore.

This is much easier than previous approach.

Vessel is approaching an anchorage slowly, angling to the weather 0 - 20°.

All mentioned previously precautions have to be taken under consideration.

If water depth and bottom characteristic permit and exactly anchor position has not been indicated by port control office, or VTS most safety method is dropping the anchor in place situated between the anchored vessels and outer limit of the roads.

In case anchor is not holding ground, problems with main engine etc., the vessel is in safety situation, she is drifting to the open sea, and time is not so important factor.

3. Open anchorage, anchored vessels are heading parallel to the coastline.

Also, not difficult approach, however all safety precautions should be observed, as always.

Remarks are very similar to mentioned under point 2.

Ship is approaching anchorage slowly, angling to the weather 20 - 90°.

The anchor is commenced to walk back at speed at two knots to avoid banging on the hull.

The anchor on weather side, not lee side should be used.

This method is known as the "Tentative".

In case planned anchoring position is close to the outer limit of the roads, for the sake of safety, I suggest to pass by bow the eye of the wind and drop the anchor from side between the shoreline and open sea.

In case of any unexpected problems, ship is drifted outside of the anchorage.

4. Open anchorage, no anchored vessels in sight.

Due to absence of another vessel, or even buoy the main acting environmental forces are not easy to recognize.

If there are not tidal waters situation is much more simple, direction and force of wind are main factors to be taken under consideration, and all basic procedures are as described in previous points.

Situation is more complicated in the waters affected by strong currents.

Conventional way of anchoring could lead to damage of the brake, or even parting of the cable.

In order to avoid such unpleasant situation safety procedures should be worked out.

The first rule:

The vessel has to arrive anchorage with bare steerageway only, keeping always enough-large safety margin to the shallow waters, danger areas and shoreline.

The second rule:

In not well-known tidal waters use of one, or maximum one and half shackle in the water is the basic guidance to tide current direction, vessel's speed and her way.

The third rule:

The amount of cable paid out at time (at once) should be of few metres only, and checked.

Assuming, we have not information about direction and rate of current, depth is known, and is let say 25 metres.

When close to desired anchor position use a short burst of stern movement.

When the "quick water" (wash) just caught the stern, anchor is let go. With one shackle in the water the brake is made fast. At this stage this is rather impossible to burn the brake lining or part the cable.

Depend on the leading the cable and vessel behaviour the following possibilities may have occurrence:

- **The anchor cable is up and down and remains in this position (fig. 5)**

It seems vessel is not moving over the ground. Most probably this is slack water, or near to. Put the cable into the gear, pay out slowly up to required length, or give the short kick astern on the main engine, and "pay out and check" as the weight on the cable comes.



Figure 5.

- **The cable is leading astern and dragging. Vessel is swinging around (figure 6).**

The tide is almost from the stern, the vessel has headway and tendency to turn around, therefore let the ship come around. To do this safely, at first kick astern on the main engine is required in order to take off the strain from the cable. That time the cable is leading most probably between 4 and 8 o'clock. When starts dragging while leading between 10 and 2 o'clock assist the swing using the main engine ahead together with appropriate amount of rudder until the anchor stops the dragging.

If stopped dragging, vessel has no speed over the ground, therefore stop the main engine and start "paying and checking" the cable as long required amount is achieved. Depending on the strain on the cable, "kicks ahead" may be necessary.

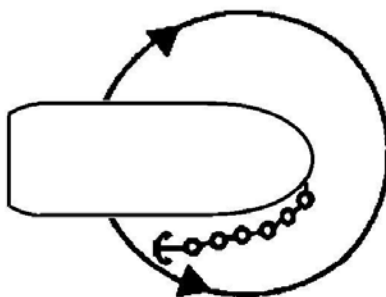

Figure 6.

- **The cable is leading astern and dragging, vessel is turning, but swings are decelerated (figure 7).**

The vessel has still headway and steaming the tide (proceeding against the current direction). Put the main engine astern until the anchor stops dragging. If stopped dragging the ship has no way upon her. Now wait, until she starts drift down the stream and the cable goes leading little a bit forward. Start “paying and checking” the cable with “kicks ahead” on main engine if necessary.

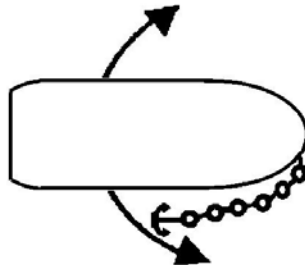

Figure 7.

- **The cable is leading ahead and anchor is dragging continuously (figure 8).**

The current is against us; vessel is steaming the tide and has gained sternway. Start the main engine and go ahead till the anchor stops dragging. Next steps are as it is advised above (“paying and checking” the cable).



Figure 8.

- **The cable is leading ahead and dragging, the ship’s stern is turning acceleratedly (figure 9).**

The tide is following us (tide from the stern), and the vessel has the sternway. It happened, because the main engine was working astern too long. Go ahead on the main engine until the cable stops dragging. The next steps to anchor the vessel are as in figure 6.

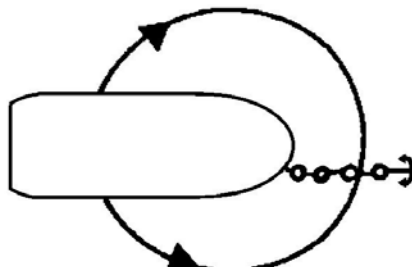

Figure 9.

5. Enclosed congested anchorage, within harbour limits, confined to a specific location.

Such anchorages are of limited space depending on type of vessel, her size and draft. The necessity to anchor maximum number of ships at relatively small area available requires dropping the anchor exactly in place indicated by local port authority. For safety reason employment of pilot with local knowledge is in most cases compulsory. It concerns especially larger vessels. The pilot is embarked shortly before arrival roads; in 99% he is very busy due to high traffic, next vessels are waiting for pilot, therefore he insist on carry out manoeuvre as fast as possible, but of course safely. Most of these pilots are in real terms the experts in this particular job, as is pilotage.

As good examples of enclosed, congested anchorages are Singapore and Cristobal Inner Roads.

In order to keep control of the vessel, speed is required and it is found the best practice to drop the anchor when ship is moving still ahead.

Due to restricted space it is not always possible (rather almost never) to choose the best approach direction, most important is precision of anchoring.

This is very useful to check main engine movement astern before arrival designated place.

In order to anchor the vessel with required precision, the anchor party on the forecastle must let go the anchor the moment is given the order from the bridge, and it must not be allowed to close the brake too soon. The officer in charge of operation on fo'c'sle plays an important role. When two, or three shackles have run out it should be possible to apply the brake, and then "pay out and check" as the ship loses her way ahead.

BASIC ANCHORING METHODS

STEP BY STEP

There are two recognised basic methods of anchoring the vessel.

1. The first, most popular is when the ship is already stopped, and has slight sternway, or moving easily sideways when the anchor is dropped /walked out.
2. The second method is used particularly within harbours limits in restricted to a specific anchorage location. As it was written above in order to keep control of the vessel, speed is required and it is found the best practice to drop the anchor when ship is moving still ahead with slow fully controlled speed.

(1)

Ship stopped and has slight sternway, or moving sideways when the anchor is dropped / walked back (out).

This method, depending on size of the vessel, direction of approaching the anchorage may be divided to:

- a) The classic method (vessels up to let say 50,000 DWT),
- b) The “Tentative” method (large vessels of DWT > 50,000),
- c) The “U” turn method (large vessels of DWT > 50,000),
- d) The modified “U” turn method (generally with necessary modifications may be applied to all vessels).

The “Classic” method - smaller vessels, up to 50,000 DWT.

- a) **Water depth is up to 20 metres (figure 10).**

The anchorage is approached slowly, steaming the wind and tide (up to wind, and / or tide, angle of approach near zero degree). Last few cables to the planned anchor dropping position vessel is passing with main engine already stopped. If the vessel is equipped with solid right hand propeller, shortly before arrival required position ship’s turn to port should be initiated by rudder put hard to port and applying “kick ahead”, if necessary.

Immediately after turn to port is commenced, put rudder amidships and the main engine at slow astern.

Now the turn to port is eliminated by the propeller transverse thrust, which under normal conditions should push the stern to port (it means also, that forward part of the ship, ahead of pivot point goes to starboard!).

When the water wash (“quick water”) reaches midship anchor is dropped, and main engine put at stop. Meantime ship shall be with head up to the wind or steaming the current. Having one and half up to 2 shackles are in the water the brake must be made fast, in order do not pile up cable on top and foul the anchor. When slight sternway is gained and maintained the cable is allowed run out until sufficient amount of shackles is paid out. Once the required amount of cable is

paid out, still without strain, (almost up and down!) the bow stopper should be put on, and secured.

The speed of the vessel over the ground when the anchor is let go, and whilst the cable is paid out, needs to be minimised. As it was stressed before this requirement is more critical for large ships. To achieve this use of main engine ahead may be necessary.

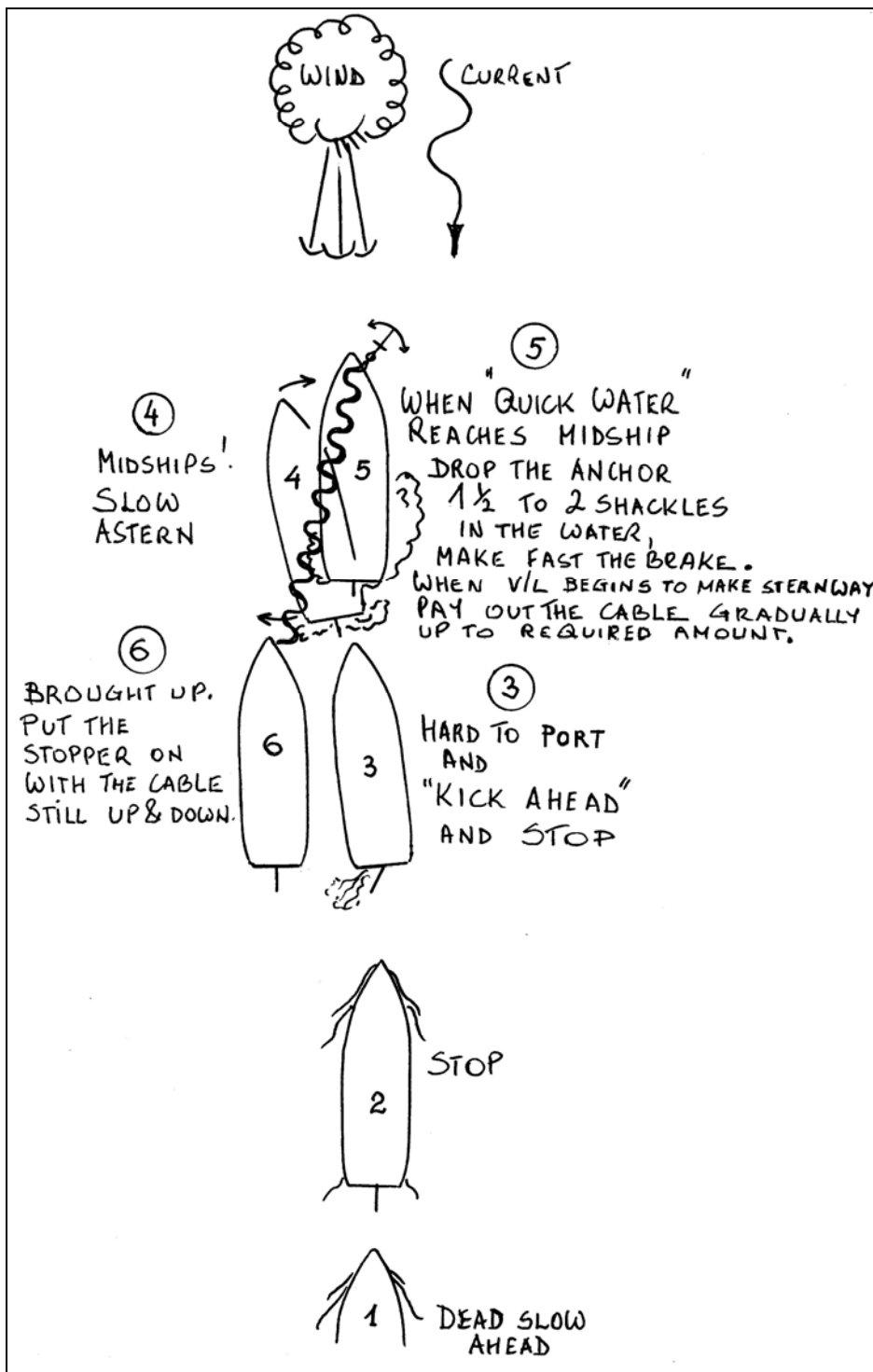

Fig. 10. The "Classic" method - smaller vessels, up to 50,000 DWT.
Water depth is up to 20 metres.

b) Depth is between 20 and 30 metres.

The anchor is at first walked out (back) until the shank is fully submerged and crown shackle seen only. The brake is applied and windlass gear disengaged. Now the anchor is ready to let go. The next steps as above.

c) The depth is more than 30, but less than 60 metres.

The anchor cable should be walked out until the anchor is within the depth, just touches the ground, or let say few metres above the bottom (but not more than ten). This is recommended as the means of restricting the velocities and loads in the anchoring system. Having the anchor touching the ground the brake is applied and windlass gear disengaged and the anchor is ready to let go. The next steps are same as under point (a).

d) The depth is over 60 metres.

As it was written before, and repeated here the windlass should be kept in the gear and cable walked out to the length required. Attention must be given to restricting the walkout speed so damage to the windlass gear and motor are avoided. If necessary the brake and cable stopper should be applied immediately, because as per class rules windlass brake is 12 times more powerful than the motor, and cable stopper, so-called pawl, or “guillotine stopper” has twice the holding power of the brake and is the strongest link in all anchoring

The “Tentative” method (large vessels of DWT > 50,000).

General remark:

The ships such as the Panamax, Cape and VLCC classes when making way through the water are developing the tremendous, massive kinetic energy.

It leads to problems with respect to:

- Slowing and stopping,
- Inadequate anchoring equipment.

Therefore a better and more effective approach to the anchoring of the large vessels is advised (“A New Approach to Anchoring Large Vessels”, by Capt. C.A McDowall).

As Capt. C.A. McDowall suggests it a better and more effective approach is to keep the anchor cable leading at right angles (90 degrees) to the bow and control the change in axial inertia rather than controlling the ship momentum.

Description and my necessary additional explanation of the first suggested manoeuvre for the large vessels – the “Tentative” method (figure 12):

The anchorage is approached slowly with the angle to the weather between 20 and 90 degrees if planned turn is to starboard, or between 10 and 90 degrees if to port.

The effect of the transverse thrust of right hand fixed propeller when main engine is working astern on ship’s heading is showed in figure 11, and it is self-explanatory why smaller final approach heading is needed when turning to port, than to starboard.

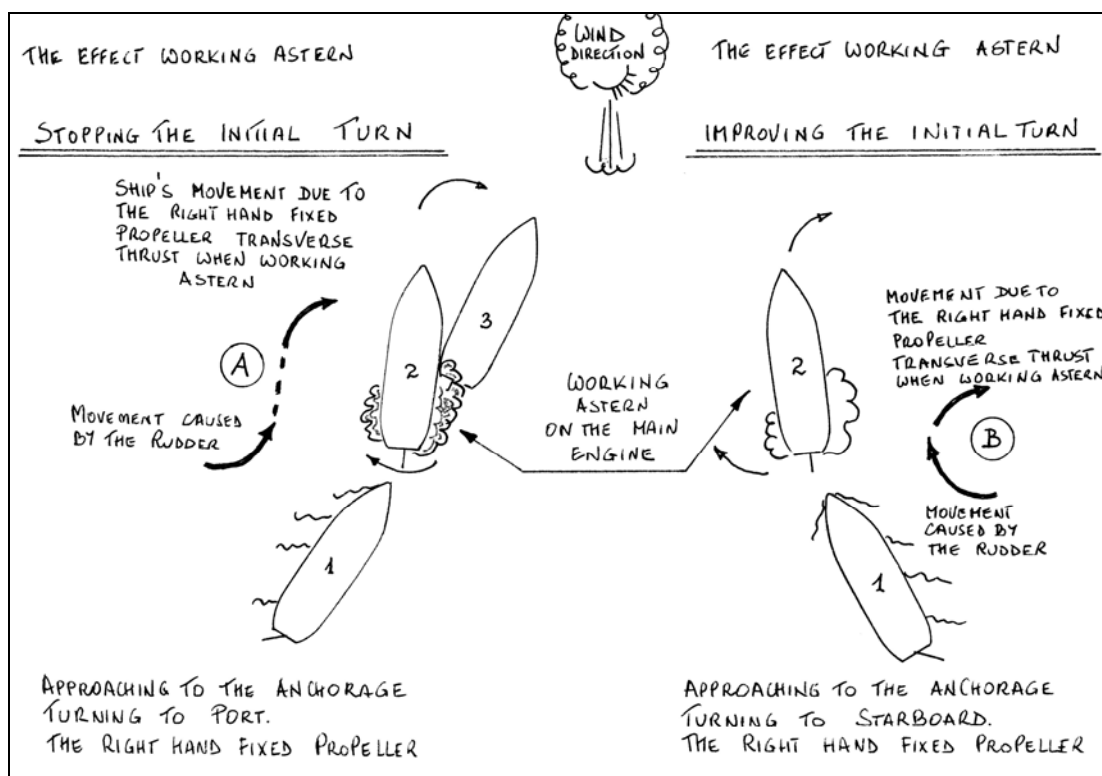

Fig. 11. The effect of the propeller transverse thrust with the main engine working astern on the final ship’s heading.

Assuming the vessel has fixed right hand propeller, and slow astern will be used only.
The weather, not the lee side anchor should be used.

The final heading, when approach is from port side depends mostly on:

1. Loading / ballast condition,
2. Trim,
3. Amount of used power astern to stop the vessel,
4. Weather condition.
5. The shape / construction of ship's stern and rudder.

The difference of about 10 degrees is as the example only, and this is the minimal necessary allowance for the propeller transverse trust, which under normal conditions should push the stern to port (as it was explained with the "Classic" method). If more power astern is applied, stronger propeller transverse trust is expected, and therefore larger angle of paying-off the bow should be seen.

The large angle of bow drift is also normal for the ships in ballast, with big trim by stern in squally, strong wind weather condition.

Knowledge of ship's behaviour in different loading / weather conditions is essential.

In order to avoid the anchor banging on the hull, walking out the anchor is commenced when speed over the ground is 2 knots only.

When the vessel is stopped, anchor is walked back (out) to just touching the seabed. On the fo'c'sle the officer in charge of anchoring operations has to observe the lead of the cable, and inform the master when leading is out on the beam, and clear of the ship's hull.

When the anchor cable starts leading in the desired direction, the brake should be opened, or cable walked out by the winch. The cable must be veered in one go to the required scope without any stoppage of the sideways movement of the bow.

The cable amount paid out, under normal circumstances should be three and half to four times the depth, even five times if it is possible.

In ideal condition, during veering the cable is on the beam, 90 degrees to the ship's fore and aft line, almost up and down. When the cable is on the beam the forces on the windlass are 20 times less (approximately 3,5 times for inertia and 6 times for added cable scope), than in classic method, where this is allowed the cable to draw ahead.

The pawl, "guillotine stopper" must be put on with the cable still almost up and down (on "short stay", without the strain on the chain), just indicating the direction of leading only.

In order to achieve and control such slight sideways movement of the ship's bow adjustment the angle to weather by "kicks ahead / astern" and appropriate position of rudder may be necessary. As it was mentioned and stressed earlier the experience in ship handling, good training, and knowledge of the particular ship behaviour are necessary, and fruitful!

There has been some evidence suggesting the weakness of the anchoring system of ships over 50.000 DWT. This worth to remember, that the strongest part in this system is always the cable stopper, which has twice the holding power of the brake, and the brake is 12 times stronger than windlass motor.

According to the above the ship's master has to instruct the officer in charge of anchoring operations on forecastle to **do not make any attempt to bring the vessel up on the brake, or the windlass motor, because this is against the maker's and class limits.**

Once again is stressed to bring up the vessel, with the cable abeam before allowing the cable to draw ahead. This is for the inertia of large vessel and scope of her anchoring system reason.

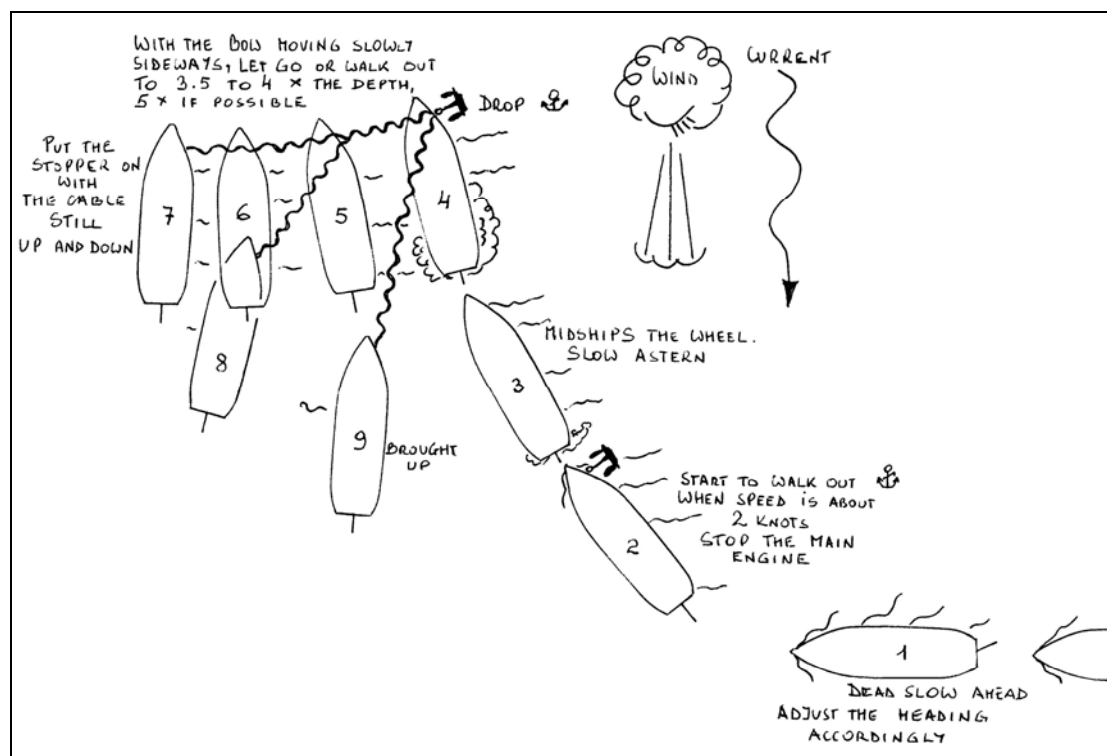

Fig. 12. The "Tentative" method (large vessels of DWT > 50,000).

The "U" turn method (large vessels of DWT > 50,000).

This is the second anchoring manoeuvre of large vessels advised by Capt. C.A. McDowell (figure 13). This method utilises the rotational inertia of the vessel to keep the control of the tension in the anchor cable.

To keep the cable leading at right angles to the fore and aft direction the bow should be positioned of about 20 degrees to the weather and moving sideways when the anchor is dropped.

To achieve this 20° angle to the prevailing weather all remarks regarding final heading, described in the "Tentative" method have to be taken under consideration. It depends on from which side the ship is approaching the anchorage (see figure 11).

If the ship's turn is planned to starboard the bow is positioned 20° off the weather at the end of tightly executed turn of about 135°.

Before the commencement of this manoeuvre the vessel should approach the anchorage down the weather at slow speed.

The "U" Turn is commenced when the bow is positioned abeam of the planned position where anchor to be dropped. Meantime the main engine is ordered to run on dead slow ahead. The rudder is put hard over towards the anchoring position.

Meantime the main engine is ordered to run on dead slow ahead.

As soon the turn is initiated the main engine should be stopped.

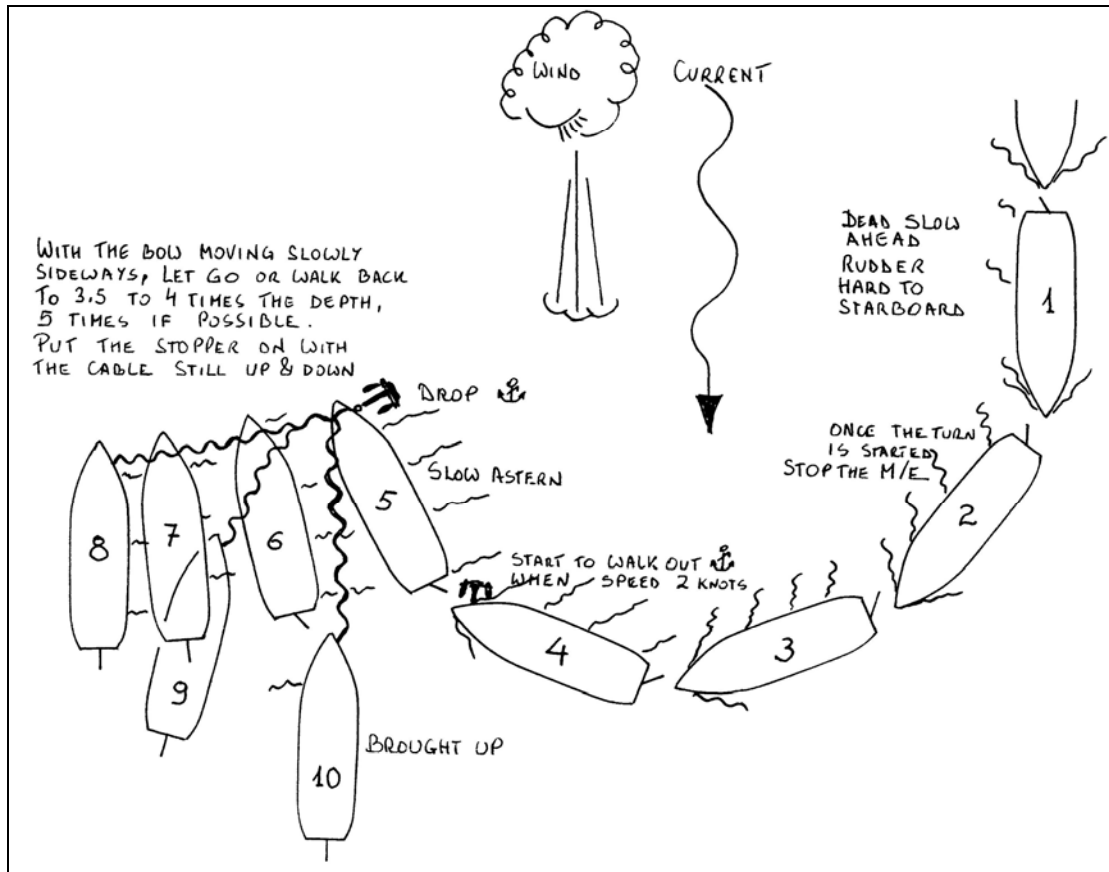

Fig. 13. The "U" turn method (large vessels of DWT > 50,000).

When the speed is of about 2 knots the anchoring party on the fo'c'sle start to walk the anchor back (out) just to above seabed. The anchor on the inside of the turn has to be used.

When the ship's heading is altered of about 135° from the initial (it means the course what was kept before starts the turn) the ship should be virtually stopped. The angle to the weather has to be adjusted as necessary in order to suit the strength of the wind and / or tide. To make such adjustment full rudder and "kicks" on the main engine are applicable / necessary.

With the bow moving slowly sideways, let go, or walk back with the brake the anchor to 3,5 to four times the depth, five if possible.

The stopper should be put on and secured by pin with the anchor cable almost still up and down without the strain on the chain, just to indicate the direction of leading only. (figures 14 and 15).

Any attempts to bring the vessel up on the brake, or windlass motor are strictly forbidden, because are against the makers' and class limits.

The ship has to be brought up with the cable leading abeam, or almost abeam before allowing the cable to draw ahead.

See also the remarks connected with the "Tentative" method.



Fig. 14. The pawl, “guillotine stopper” form the integral part of the anchor cable restraining equipment and is designed to take the anchoring load.



*Fig. 15. Once the required amount of cable has been paid out, the vessel should be allowed to bring-up on the bow stopper.
In any manoeuvring on the anchor the stopper should normally be engaged.*

The modified “U” turn method (generally with necessary modifications may be applied to all vessels).

This method may be applied to all size vessels.

The main modifications are:

- Delayed commencement of turning the vessel.
- The main engine is not stopped once the turn is started, but kept at dead slow ahead longer, up to reaching heading different of about 135° from initial.

The advantages are as follows:

- Additional distance achieved by delaying the turn is used to make necessary adjustments in course and speed of approach, and therefore with some effort, experience and good will on the ship handler side the anchor should be dropped exactly in the planned position.
- Because dead slow ahead on the main engine is kept longer it allows ship faster answering the helm and master better control of the ship’s behaviour.
- The slight sideways movement of the bow (large vessels), as well heading up to wind and tide (classic method) are fully possible to realize in the final stage of this manoeuvre.
- This method may be easy adjusted to suit accordingly particular requirements.

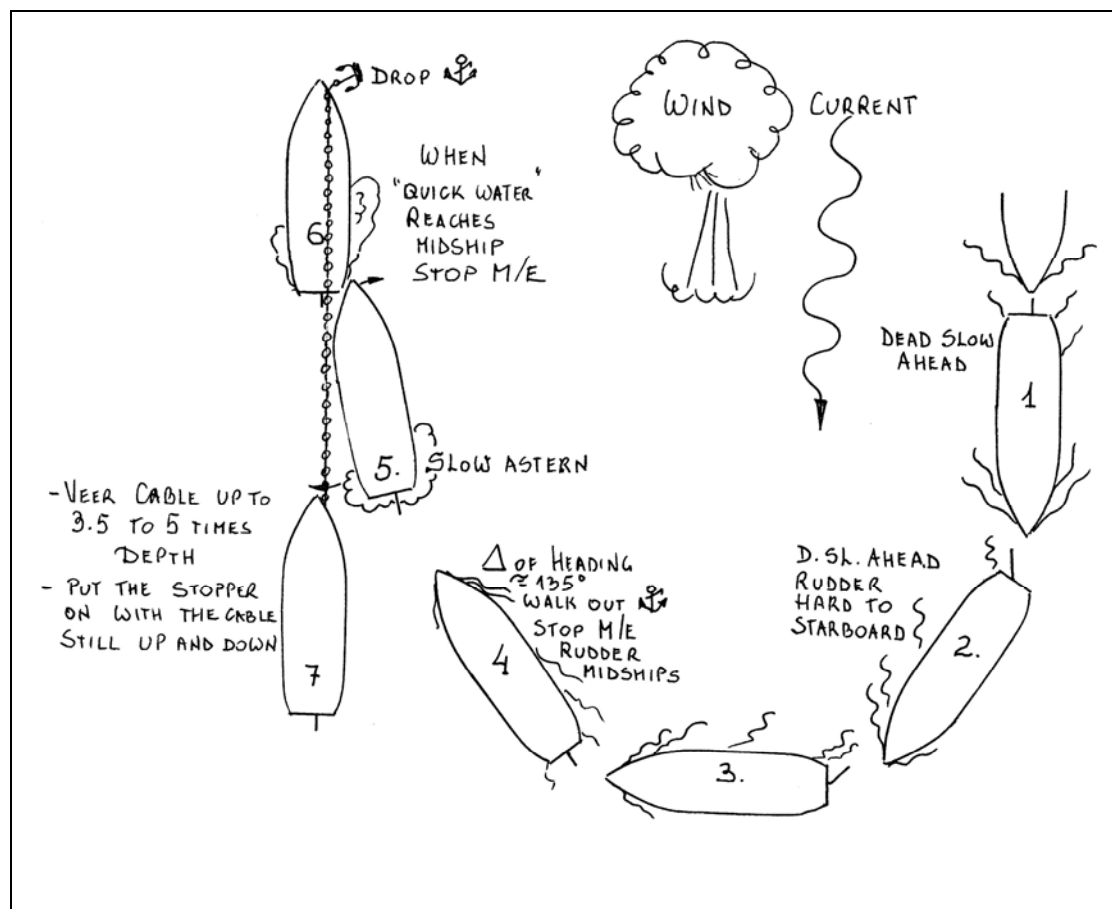

Fig. 16. The “Modified U-turn” method.

(II)

Ship is moving still ahead with slow fully controlled speed.

This method is used mostly at the congested anchorages of limited space (figure 17). The necessity to anchor maximum number of ships at relatively small area available requires dropping the anchor exactly in place designed earlier by local port authorities.

The main difference of this method to these previously described is dropping the anchor when the ship is still making the headway.

Because precision of dropping the anchor is most important factor the slight speed ahead is necessary to keep the control of ship's movement all the time. The speed should be of such amount, that all way could easily be taken off after the anchor is dropped.

The best approach direction is almost never possible to choose due to restricted space available.

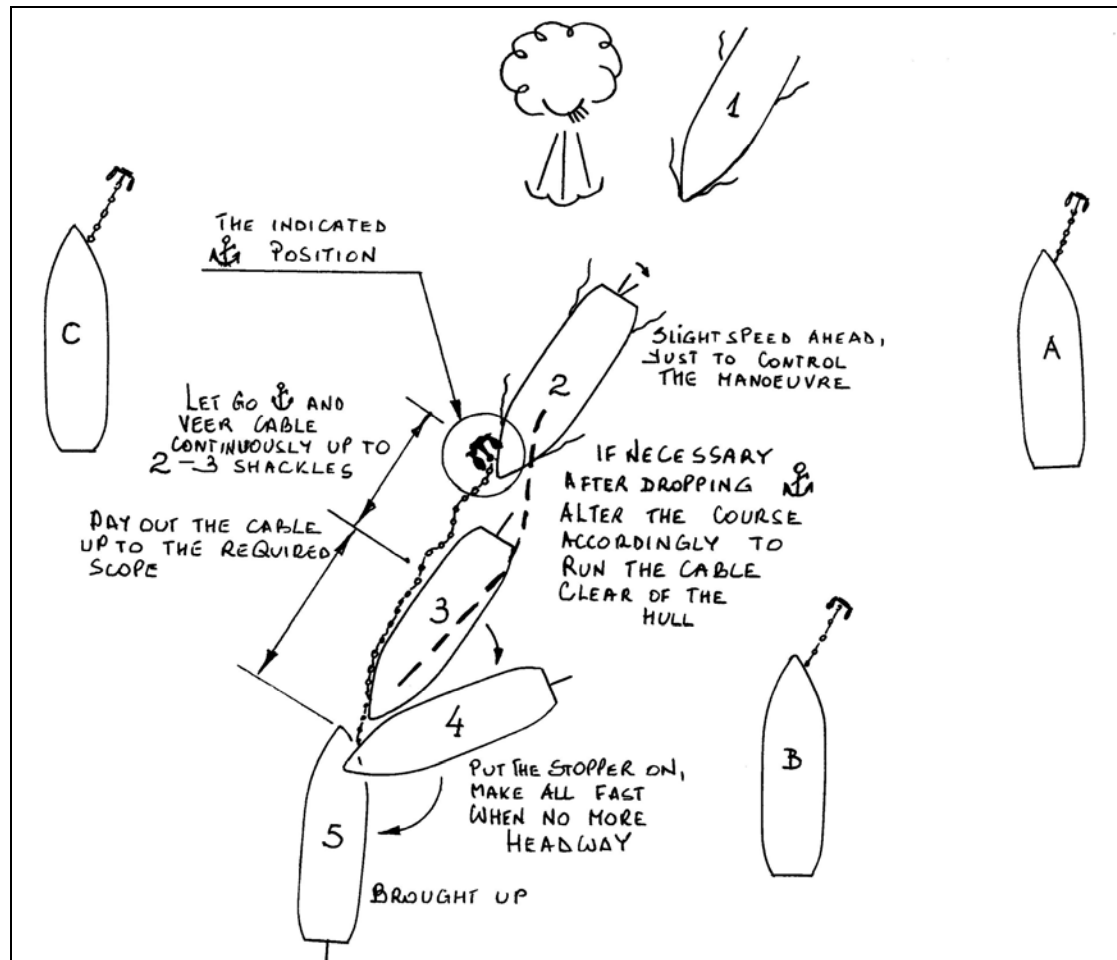

Fig. 17. Dropping the anchor with headway.

In order to anchor the vessel with required precision, the anchor party on the forecastle must let go the anchor almost exactly when the order from the bridge is given. But if there is a delay in dropping the anchor, or anchor was let go too early it

will be necessary to make one more approach, what not always is easy, convenient and safety at the small and crowded anchorage.

Of course pilot or master should always keep in mind the necessary allowance of few seconds needed for releasing the brake.

The brake must not be closed too soon. Lot depends on the officer in charge of operation on fo'c'sle.

This is not so important which way the vessel is heading at time of let go the anchor, but if necessary this is suggested to alter the course accordingly to run the cable clear of the hull.

When two, or three shackles have run out it should be possible to apply the brake, and then "pay out and check" as the ship loses her way ahead.

The officer in charge of anchoring operation on fo'c'sle should report to the bridge each shackle of cable run out, but he must remember **DO NOT STOP** the cable to check the numbers of shackles already paid off. If the depth is 25 –30 metres with one, or one and half shackle in the water the anchor will be dragged along the seabed and precision of dropping the anchor is lost, the whole manoeuvre will have to be repeated.

With all the required shackles already run out, the brake is closed and meantime ship's speed ahead should be completely taken off.

In order to loose the rest of headway the brake should not be applied too strong.

The method of "paying and checking" is recommended, especially when vessel is large and deep laden.

Because the anchor cable is not designed to support a sudden jerk, it is always better to slack out more cable until final stopping of the vessel.

Heaving up to required amount of shackles is carried out later with vessel already stopped and brought up.

HEAVING UP THE ANCHOR

In normal weather condition there is no problem to weigh the single anchor. The officer in charge in forward station should inform the bridge how the cable is leading and about the strain on the anchor chain. If there is leading astern, windlass must be stopped due to heavy tension in the anchoring system.

Each shackle appears should be announced by appropriate amount of the bell rings. When the anchor is aweigh the bell is rung rapidly and anchor ball lowered.

In the case of stormy wind and rough sea, or strong current, there is the significant strain in the anchoring system. Working on main engine ahead, and steaming towards the leading cable / eye of the wind / current is the must to ease the system, particularly the windlass.

The pawl (guillotine bower stopper) always must be put on in heavy weather conditions for the very simple reason; when the bower stopper is put on there is possibility to heave up anchor only, any uncontrolled paying back is automatically halted.

The officer on fo'c'sle shall immediately inform master when strain on the cable is decreased in order to stop the main engine.

There should be two men on the controls, particularly the brake.

In heavy weather conditions safety harnesses must protect all crewmembers employed at fo'c'sle.

Sometimes the anchor is dropped by mistake or negligence in such deep water, that the windlass is not able to lift the anchor and full amount of the cable paid out (almost all ships are designed to the 82 metre rule).

At first it is necessary to heave up maximum amount of chain, as possible, and then proceed towards the shallower water in which the windlass motor has enough power to recover remaining scope of cable and the anchor.

Such unpleasant situation takes place sometimes aboard ships with windlasses in poor condition.

THE SECOND ANCHOR

(I) GENERAL REMARKS

The main purposes of use the second anchor are as follows:

1. Restriction of yawing and therefore avoidance of dragging during stormy weather condition, or strong current.
2. Reduction the chance of cracking the chain during rough weather, or strong tide current, by lessening the strain in the individual cable.
3. Minimizing of the swinging area,
4. Securing the vessel stern on to the berth with both anchors leading ahead to hold the bow in position (Mediterranean Moor).
5. Berthing large tanker to the Sea Berth (Conventional Buoy Mooring).

(II) UNDERFOOT

Yawing

Because on board almost all merchant ships the bow hawse pipes are two, and therefore not situated at centre of the bow, the vessel's natural position when lying at one anchor becomes canted just opposite to the anchor.

With the increase of the strength of wind or tide, the vessel anchored at one-anchor starts yaws about.

The vessel starts falling off the wind or tide exposing the one side of bow more, than the other and drifting sideways until she is stopped by the cable tension.

The path traced out by a starboard-anchored vessel (exactly her starboard hawse) is shown in figure 18. This path has configuration of "8". The asymmetry of the halves is caused by off-centre positioning of the used hawse pipe. This asymmetry becomes larger with the hawse pipes situated more aft, closer to the extreme ship's beam.

In figure 18 it is seen, that between positions "A" and "D", and "B" and "C" the sheer is increased.

The tracks between "C" and "A", and "D" to "B" show the surge ahead, caused by the extreme anchor cable stretch and reduction in hull pressure.

The angle of swinging (yawing) depends on the wind force, tide rate, vessel's trim and draft.

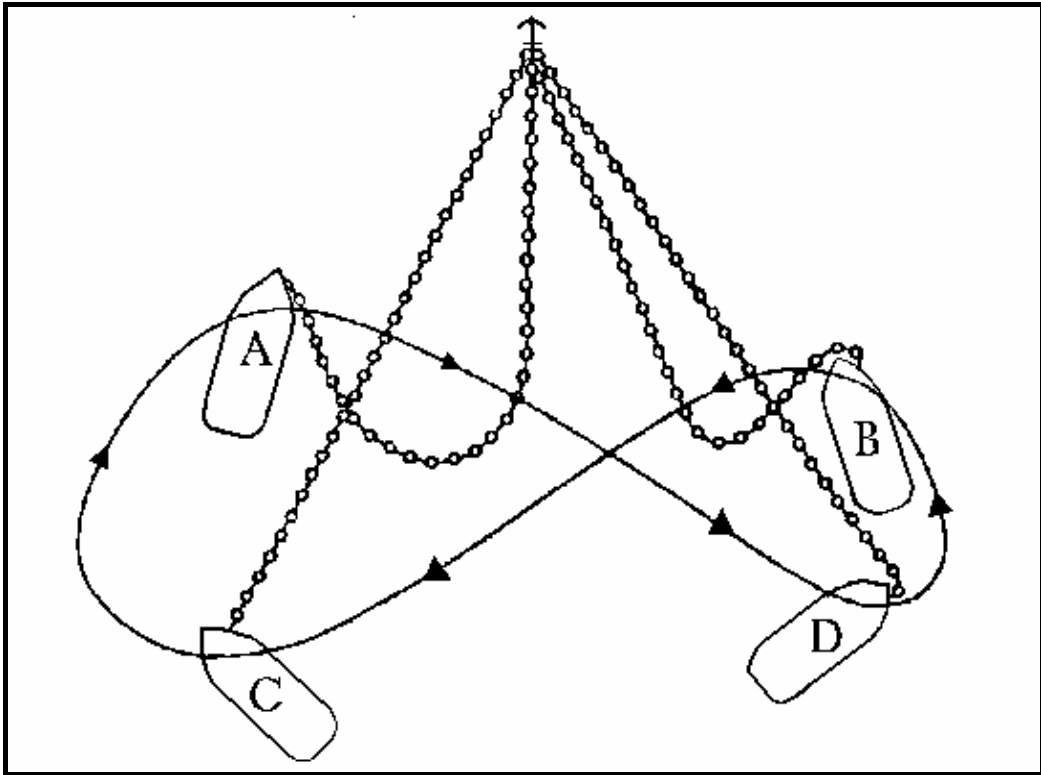

Fig. 18. The path traced out by a starboard-anchored ship's hawse.
The anchor starts dragging or in the worst condition the cable is parted in positions where the sheer, and therefore forces are maximum.

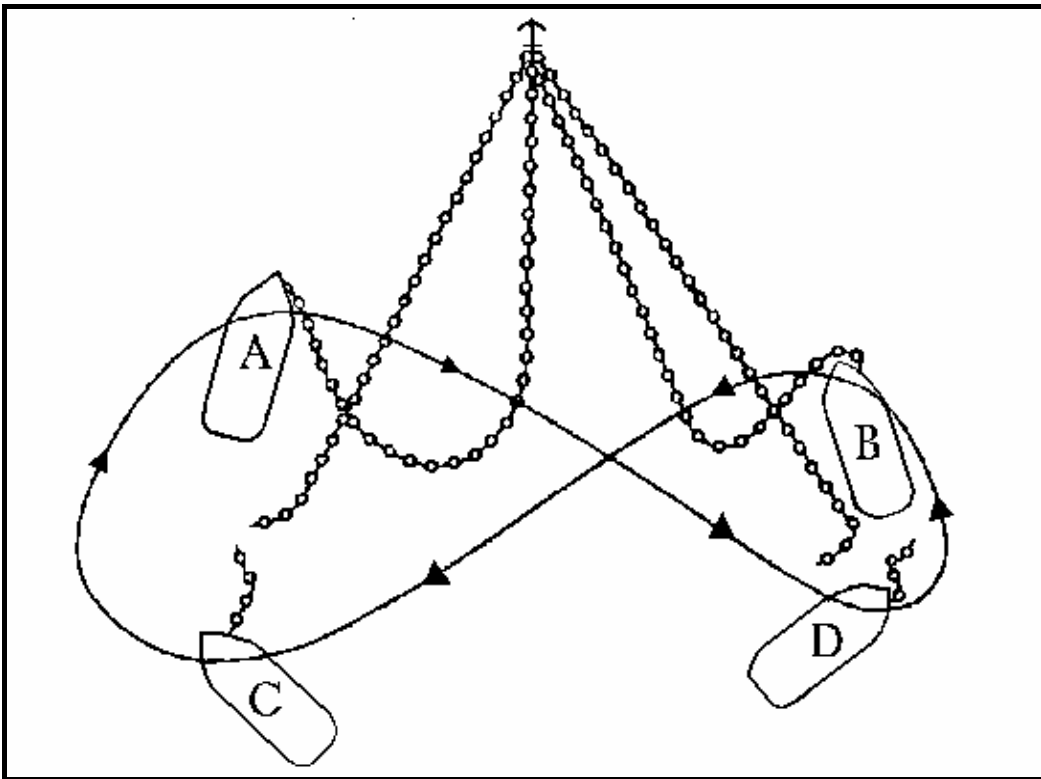

Fig. 19

Such extremely situation is showed in figure 19.

“Underfoot” anchor

Lessening the yawing will decrease the forces in the anchoring system.

The common practice to arrest wild yaws used aboard high windage ships, as are car carriers is to drop the second anchor “underfoot”, with amount of cable equal to 1,5 (one and half) distance from the hawse pipe to the bottom (figure 20). It works nicely with the water depth of about 30 –35 metres only.

If the depth is less, than 25 metres I prefer to put just at the seabed the second anchor, with one, maximum one and half shackles in the water.

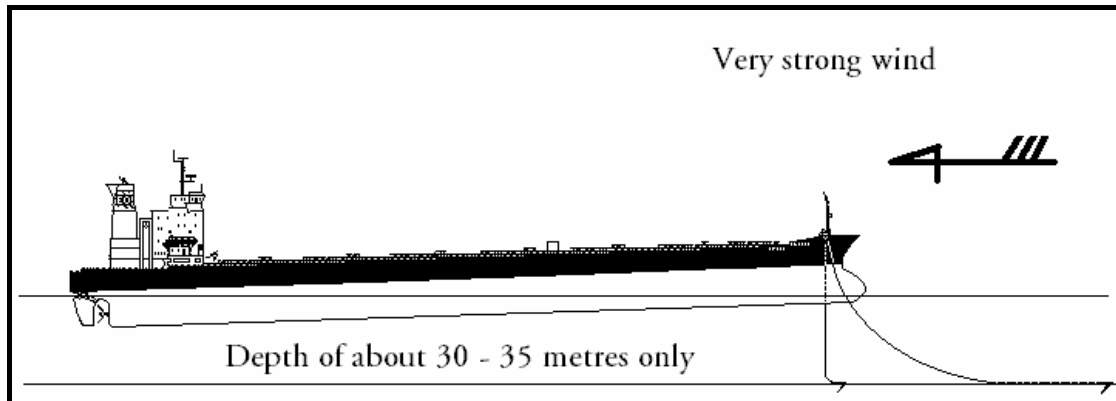

Fig. 20.

The second anchor task is to arrest yawing, not to hold ground. The protection against fouling the cables is fact, that underfoot anchor is dragging all the time, and both anchors cables are “growing” under different angles to the bottom.

When the wind or current is changing direction, but the force is still same, or even stronger, there is not chance to foul the cables.

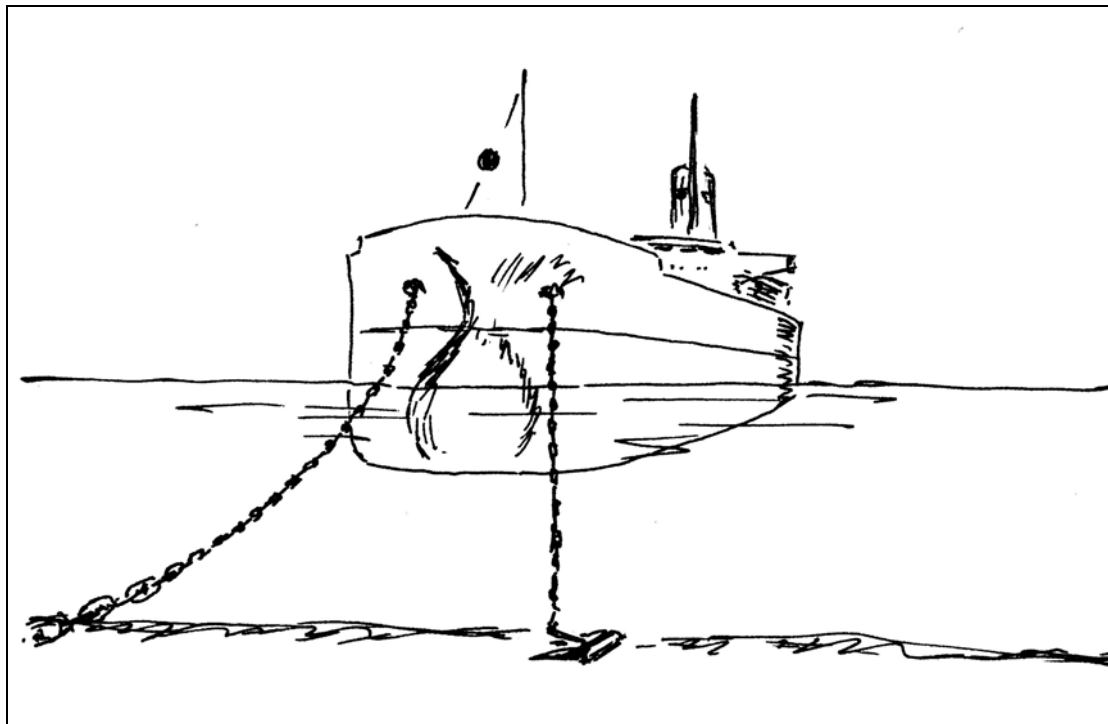

Fig. 21. The second anchor dropped “underfoot”

With deeper depth the second anchor should be dropped with three shackles on deck theoretically in position marked “C” (fig. 18), because this is extreme distance between the anchors. As per my own observation and experience dropping the second anchor in position “C” will decrease the yawing, but also increase the strain in the riding anchor, because the angle between the anchor chains is almost 180°. Seems, that more convenient position is situated in the middle between “C” and “A”. The angle between the cables is sharper, but the distance remains still satisfactory. See figure 22.

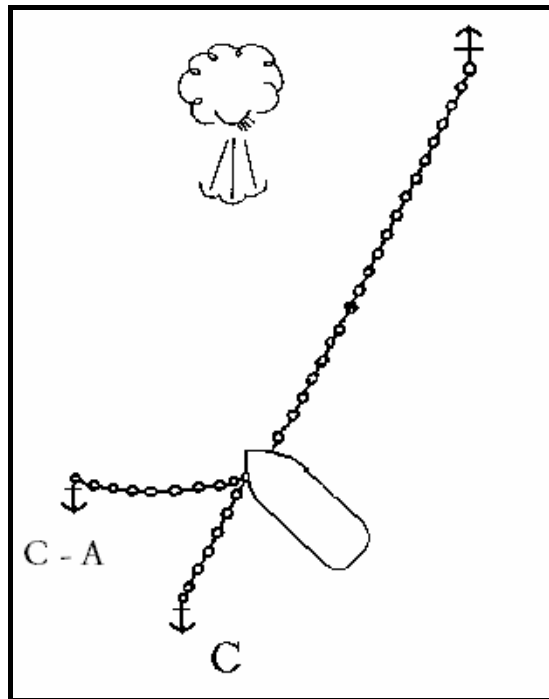

Fig. 22. “C-A” position is better for dropping the “underfoot” anchor.

Suggestion regarding heaving up the anchors

In this case when it is necessary to change, or leave the anchorage this is suggested to heave up at first the shortest cable up to one and half shackles in the water, and put out from the gear.

Next step is to start to heave up the riding anchor. Heaving up should be assisted by main engine and appropriate amount of rudder.

With three shackles of the riding anchor in the water - there is change over and continuations of heaving up the cable of underfoot anchor completely.

With the second anchor aweigh and clear, the riding anchor is put in the gear and heaving up directly.

Practical observations:

It was noted, that the “underfoot” anchor with three and half shackles on the winch is holding the ground, without signs of dragging. That time depth was little more, than 40 metres, muddy seabed, open sea (about 90 Nm to Recalada Pilot, La Plata River, Argentina), rough sea with the waves of 3 up to 5 metres high, and WSW wind force 7 Beaufort (30 knots).

The vessel was bulk carrier of 28000 DWT, in ballast, with draft forward 4.40m, and aft 6.80 m.

The starboard side anchor with eight shackles on the winch was dropped first as the riding anchor. The weight of each anchor is 6500 kilograms.

The angle between maximum positions of yawing after dropping the second anchor was restricted to 30°, with period of about 4 minutes (measured between swings: maximum to port side and maximum to starboard side).

The most important was evident decreasing the jerks on the cables.

The anchor cable periodically lowered or heaved up at the distance of few metres in order to minimize “tear and wear” of the links passing the lower edge of hawse pipes. Meantime working links have been greased.

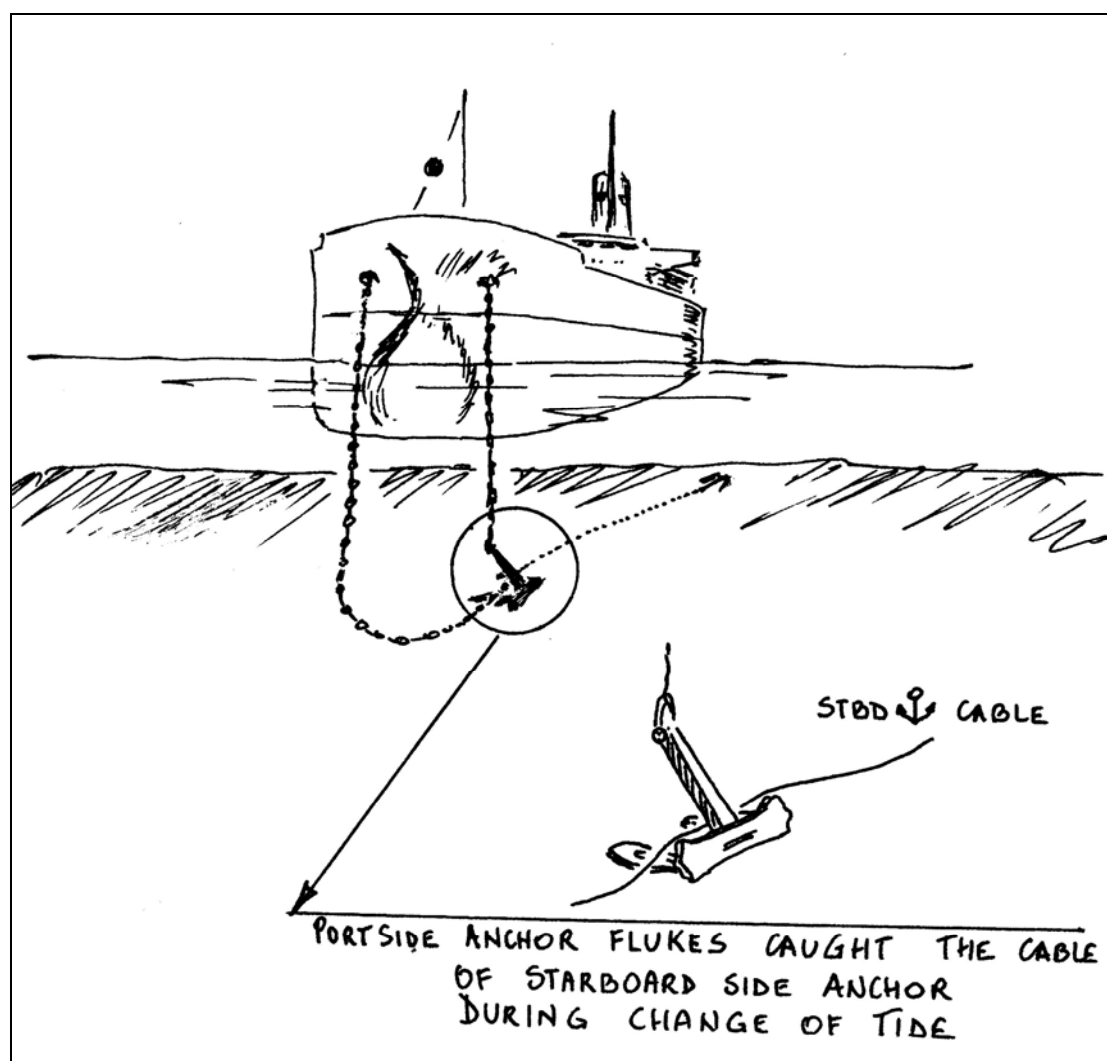

Fig. 23. The slack water, calm sea and the “underfoot” anchor flukes caught the longer cable of the riding anchor.

As it was observed, the possibility of catching the longer cable by the flukes of underfoot anchor even with one, one and half shackle in the water exists, but only in the case when force of wind, or tide is lessened and meantime the ship has been swung around (fig. 23). It may happen particularly during period of slack water and

almost calm sea when in the first phase of turning the ship has the surge ahead due to the weight of riding anchor cable.

To avoid such unpleasant situation the second anchor should be heaved up shortly after passing the stormy weather, or strong tide.

Anyway “making free” the underfoot anchor flukes is not so difficult to compare with the situation when both cables are fouled.

It was another interesting observation made during calm weather and slight tide current, that the “underfoot” anchor held the vessel in position with its cable tight. The other cable was that time up and down. Obviously the weight of cable of the riding anchor took its part in holding ground too.

(III)

ANCHORING MANOEUVRES WITH TWO ANCHORS TO RIDE OUT A CYCLONE (HURRICANE, TYPHOON)

At page 104 of NP 100 “The Mariner’s Handbook”, Chapter 5, paragraph 5.36 is written:

“Riding out a tropical storm, the centre of which passes within 80 miles or so, in a harbour or anchorage is unpleasant and hazardous experience especially if there are other ships in company.”

Unfortunately it may happen; therefore the basic information and methods are given below.

When vessel is lying at one anchor with the increase of the strength of wind she start starts yaws about.

Because of heavy veering (yawing) dragging is undoubted.

To reduce the dragging to a minimum it is advisable to use both anchors. Some methods to ride out hurricane on two anchors applied in past with success.

These methods are mentioned hereunder.

Riding to two anchors

If both cables are leading almost ahead, and both of them are taking the strain it is said that vessel is ridding to two anchors.

From the physical point of view (the triangle of forces) this is the best security from two anchors. If the holding power of one class “A” anchor under the best condition achieves 4 – 6 times the anchor weight, with two anchors drawing almost ahead together holding power is almost doubled.

As it was told before, the part of the chain lying on the seabed is also added to the anchor's holding power.

This is worth to remind, that the cable load is calculated for forces with the chain straight or nearly straight ahead, and therefore this method seems the best.

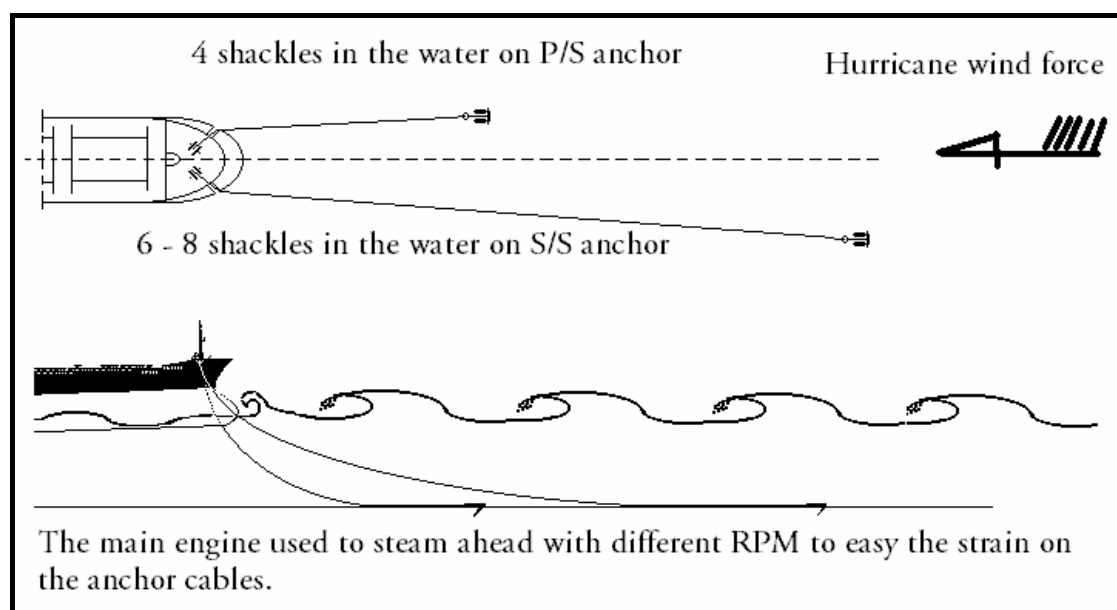

Fig. 24. Riding to two anchors.

Unfortunately this manoeuvre can be applied only in case we are sure of the side to which the hurricane passes. Otherwise both cables most probably will be fouled.

One of the remedies against fouling the anchor chains is paying out different amount of shackles in both cables, as it is seen in figure 24.

Anyway this is unlikely to be riding to two anchors for long period.

Shortly after passing the worst, strongest winds the anchor with shorter cable (so called "sleeping cable") should be heaved up, and dropped again after shifting of wind.

For example the best time to heave up this anchor is short relatively calm period, when in the eye of hurricane.

The main engine has to be used to steam ahead in order to easy the strain on the anchor cables.

The revolutions of main engine used in this case depend on the power of main engine, type of vessel, her draft, loading condition, etc.

According to some practical experiences mentioned in "The Evasion of Tropical Cyclones" the main engine was used with revolutions for 3 to 5 knots.

During my apprenticeship in 1973-74 aboard Polish Ocean Lines ship "Pekin" (general cargo motor vessel, of about 10000DWT) her master Capt. T. Kalicki told us, this vessel one voyage earlier had weathered a very severe cyclone in Australian waters riding to two anchors, with almost parallel cables but of different scope of shackles on each (7 shackles on port side anchor chain and 10 shackles on starboard side one, with depth of 12 fathoms). In order to keep her in position without dragging slow ahead on the main engine was used, and half ahead rung occasionally only.

According to the reports of masters who have experienced riding out typhoons at anchors the vessels, which did not use their engines dragged even for 8 to 10 miles.

When it become obvious that the wind will increase to typhoon force the man should be posted on the forecastle to inform the bridge regularly about the direction in which both cables are leading. This is very important particularly when working ahead on powerful engine (reefer, container vessels). The man sends forward should be well clothed in waterproof, good “oilskin” and equipped with goggles (for example such as used while chipping the rust), safety harness, and of course waterproof hand held VHF. He should take the position lying on deck in the “panama fairlead”.

This is common practice in the Japanese waters to send all vessels being in port to the roads when typhoon is coming. The anchorage becomes congested; **therefore keeping at least one mile to the nearest vessels is advisable in order to avoid troubles shortly after the anchors start dragging.**

This is recommended to keep minimum 5 (if possible) off the lee shore.

The distance of 10 – 11 miles is much better due to experiences learned before that some vessels dragged for more than 3 miles in one to six hours. The average drift was of about 1,6 knots.

The wind force in typhoon is tremendous; therefore vessel’s drift has considerable rate, and this is always better to anchor the vessels in safety distance from the other anchored ships.

In September 1991, in Nagoya Bay the heavy lift vessel “Cony” under my command was not able to bring her bow against the wind when the change of the anchor position becomes necessary because ship’s high holding-power (HHP) anchors commenced dragging. After heaving up anchors, even with her two rudders put hard over and both engines working full ahead (lee side engine was overloaded for significant period of time) the drift angle was between 90° and 120°. From our lee side on the distance of about one mile was anchored just few hours before small tanker. This distance and determination in use full power on the main engines have preserved us from the serious collision. I have not decided to use one anchor dredged, nor the bow thruster due to necessity of decrease the power of main engines. **I suppose the effect of working bow thrusters in such extremely weather conditions is slight or even nil.**

“V” form with the second anchor on the bottom

This manoeuvre is one of the variations of “underfoot” anchor.

The proper sequence of dropping the anchors is vital, and depends on the position of vessel to the track of the typhoon.

Let say the ship is anchored south of the typhoon. The eye track is predicted as ENE-ly; therefore veering the winds after the centre has passed is expected. See figure 25. For the sake of good understanding, let us remind, that veering of the wind means that the direction of wind is changing clockwise (for example: SW – W – NW – N, etc).

At first the vessel has to be anchored at port side anchor with 2 up to 4 shackles more paid out, than in normal condition (we can say 7 to 9 totally).

When the vessel starts veering, the second, starboard side anchor is dropped with the amount of cable equal of the depth plus 10 metres to half shackle more. That time the port side anchor chain should lead more, less 3 to 4 points (35 - 45°) to the fore and aft ship’s line.

The anchor with the shorter cable must always be on the side to where shifting of wind is expected.

To prevent both anchors holding the vessel in one direction the anchor with short cable should drag, and this is our intention.

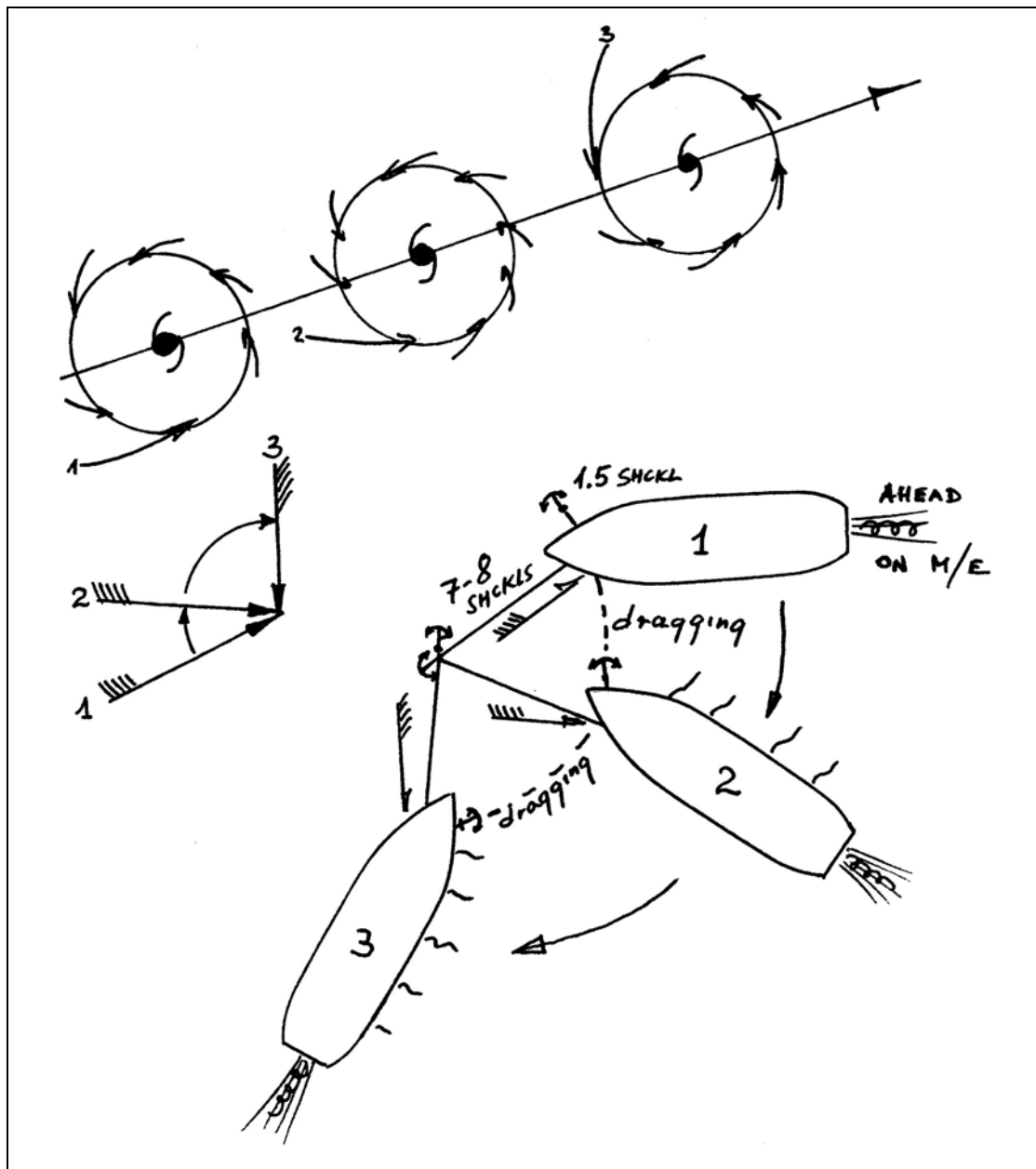

Fig.25. "V" form with the second anchor on the bottom.

"X" form with the second anchor on the bottom, so-called "Hammerlock Moor"

This is another variation of "underfoot" anchor.

Some captains have good experience with this type of manoeuvre, however having crossed anchors cables in the typhoon seems strange and dangerous.

Captain J. Price from U.S. Navy named this manoeuvre "Hammerlock Moor".

This beginning of this manoeuvre is almost same as “V” form. The shorter cable is not on lee, but on the weather side, and both anchor chains are crossed. See figure 26. In order to simplify explanation, let say the typhoon is passing anchored vessel as it is mentioned in the previous part. The first is dropped the starboard anchor with 7 to 9 shackles in the water. The second anchor is the port side one, and is dropped at the end of the veer with paid out 10 metres up to half shackle more, than the present water depth. Under normal condition it should be one and half shackles in the water. The main engine always can be used, as long we are able to hold the bow fast in position with a “Hammerlock Moor”.

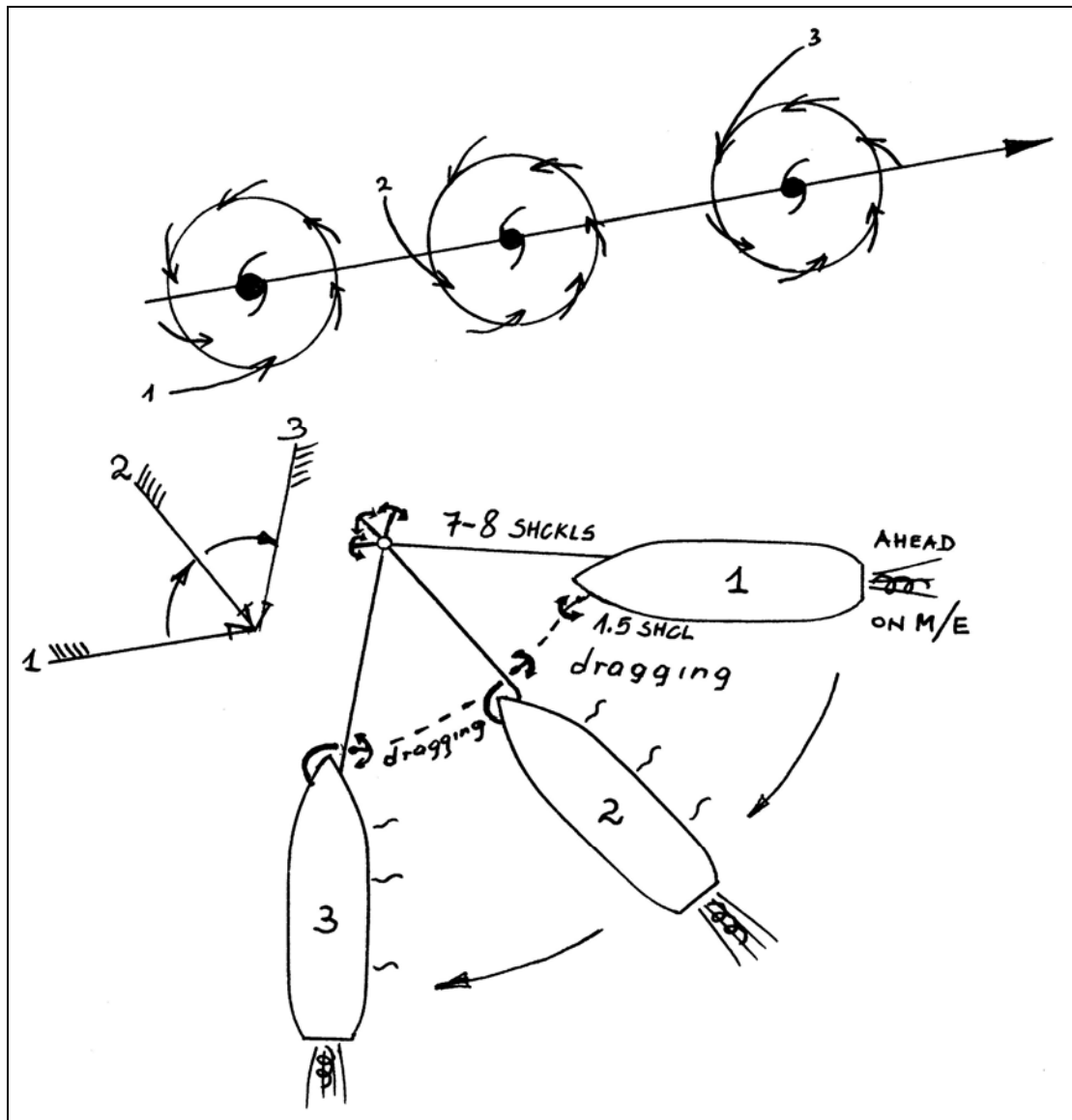

Fig. 26. “X” form with the second anchor on the bottom, so-called “Hammerlock Moor”.

In order to keep proper main engine revolutions and do not override the anchors one man must be on forecastle and inform the master about the lead of the anchor-chains. See also the remarks on this subject under “Riding to two anchors”. This man reports are necessary in order to keep the cables growing forward at an angle of 45° to 60°.

As it was stressed before with “V- form” moor the anchor with short cable should start to drag when the wind shifts around.

If not dragging, but still holding the ground there is an increase in angle between the cables. To avoid this, the main engine RPM must be reduced, or if this has no effect, the shorter cable should be shortened up.

As Dutch captains observed it, there is a chance to get fouled anchors (turns in the chains) if the vessel is anchored during the cyclone in the place where a strong current runs against the wind direction.

Because fouled anchors are dangerous under tropical revolving storm circumstances it is recommended in the waters with strong current running against the wind to heave up the anchor with short cable just before the ship starts swinging and to drop again after the end of the swing.

This is very interesting observations made by Capt. Price and given in the Dutch seamanship book “Handboek voor Zeemanschap” regarding comparison of the methods.

Type of Anchor Manoeuvre	Wind Force (knots)	Veer		
		Max.	Min.	Average
One anchor	35 - 45	72°	35°	55°
2 anchors (open hawse pipe)	35 - 45	43°	22°	35°
2 anchors (“Hammerlock Moor”)	35 –50 (65 gusts)	11°	1°	5°

It was observed no extra weight on the cables during change veer direction from one to another side.

As it was many times stressed before the bower stoppers must be put at the place and well secured, because these are the strongest parts of the anchoring system.

The RPM on the propeller used during mentioned above manoeuvres									
Wind Force (°B)	7	8	9	10	11	12			
Wind Force (knots)	30	37	45	52	60	65	75	90	100
RPM made for a speed of	1	2	3	3,5	4	5	6	7	8

“Running Moor” with the wind kept two points on the bow

This manoeuvre is recommended in Japanese waters. See figure 27.

Assume the typhoon approaching from the southwest, and its track direction is northerly. The wind is expected to veer from the east, by south, southwest, west to northwest.

The vessel is anchored at both anchors dropped almost in one line, as it is seen in figure 27-A. More shackles are paid out on the port side anchor chain, than on the starboard side one. The wind direction is kept 2 points (22,5°) on the starboard bow. When the wind veers from east to south and wind force is reaching typhoon strength, the amount of cable at starboard anchor is added until both anchor chains are same length (Fig. 27-B). That time the angle between the cables should be of about 45°-60°.

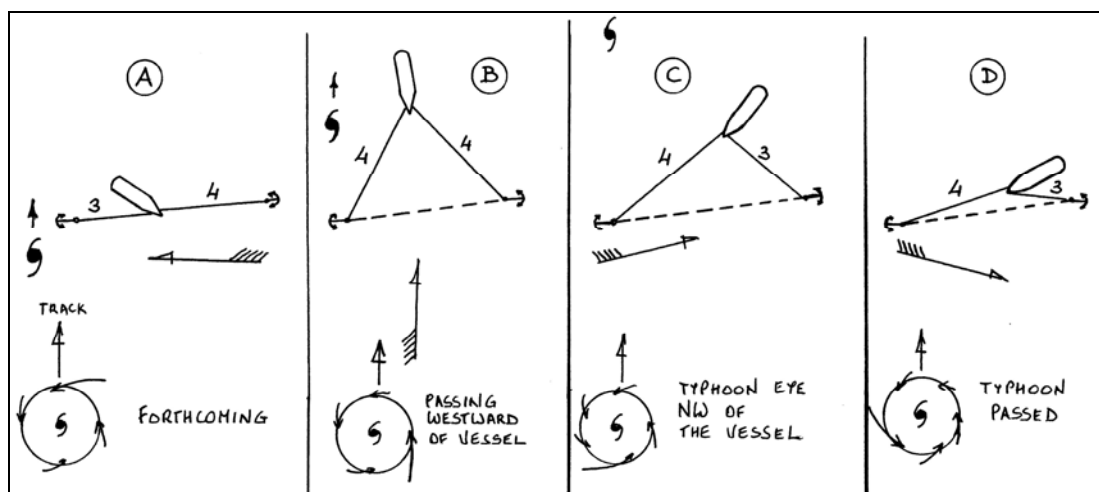

Fig. 27. “Running Moor” with 2 points on the starboard bow.

With the wind veering the role of riding anchor is passed on from the port side to the starboard anchor, and meantime the cable on the sleeping anchor is shortened up, as it is seen in figure 27 C, and 27 D.

Reassuring:

In this method both anchors are holding ground, always the windward is the riding anchor, apart the period of the strongest wind force, when they are working together as in open moor. On the riding anchor are always more shackles paid out, then on the sleeping one.

“Hammerlock Moor” X 60

This is another manoeuvre recommended by Japanese seamen (The Tokyo nautical College) and given in figure 28.

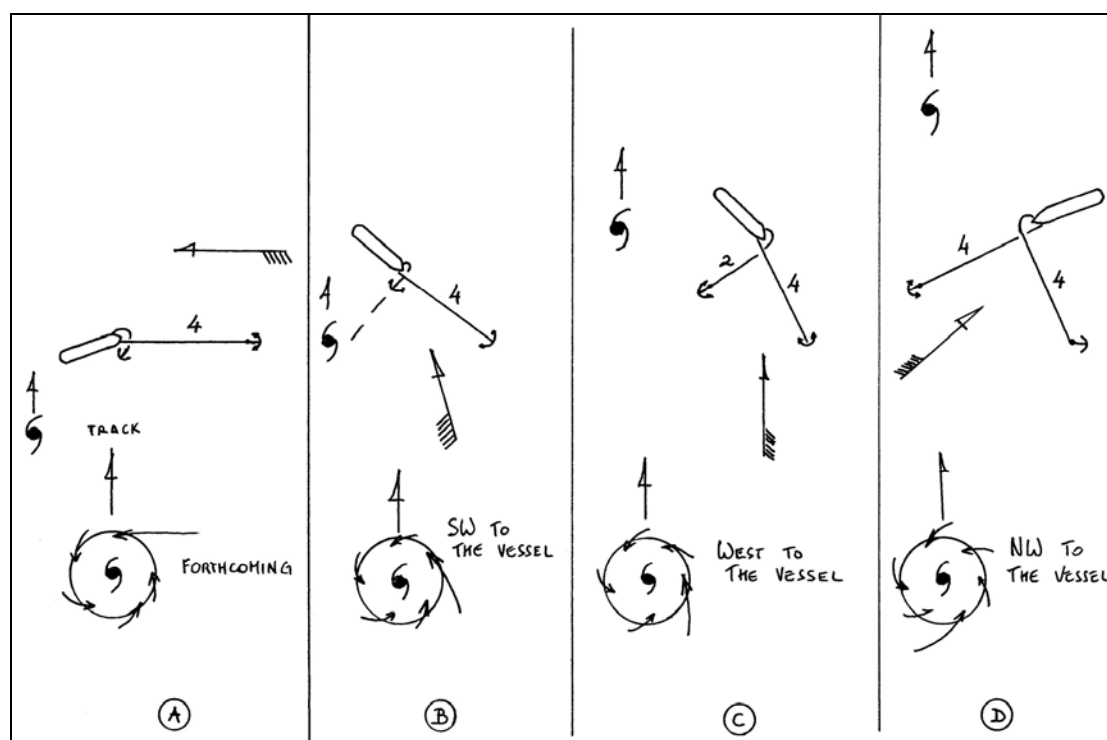

Fig. 28. “Hammerlock Moor” X 60.

The situation same as before, the typhoon approaching from the southwest, and its track direction is northerly, and therefore the wind is expected to veer.

In figure 28 A, with easterly wind the ship is anchored at the starboard side anchor. The port side anchor is dropped just to the bottom with the chain crossed, i.e. a so-called “Hammerlock Moor”.

When the wind starts shifting, the anchor with the short cable (port side anchor in our example) will drag until the wind force is increased (figure 28 B).

At the moment that the wind force reaches typhoon strength the cable of this anchor has to be paid out until the lengths of both anchor chains are same, and the angle between the cables is of about 60° (figure 28 D).

Remarks regarding methods recommended in Japan.

1. This is not always possible to operate the windlass while a typhoon is passing.
2. The typhoon surge or tidal wave can bring a strong current.

3. Departure from the harbour being situated on the track of the typhoon should be carried out 9 hours before the time the weather forecast indicates the passing time. To evacuate a harbour full with the vessels is taking minimum 6 hours.
4. The anchoring position should be chosen in such place that vessel is well protected against the winds and waves. The side of the ship the centre of typhoon shall pass must be taken under consideration when choosing the anchoring position.
5. The deepest part of the Bays should be avoided, due to the fact, that in those places the strength of the current caused by the tidal wave will be strongest.
6. The distance of 5 to 11 miles to the lee shore is advised in order to have enough room of the anchors starts dragging when the wind shifts around again.
7. Take under consideration the two recommended by Japanese Sea Authorities ways of anchoring the vessel in typhoon (i.e. "Running Moor" with 2 points on the starboard bow, or "Hammerlock Moor" X 60).
8. It has been experienced, that vessels with a deep draft were dragging anchors rarely; to compare with ships in ballast, therefore all possible means to increase vessel's draft has to be used.
9. The decreasing of ship's stability due to free surface effect, and the list obtained when abeam to the typhoon wind must be taken under consideration.
10. The tests taken in Japan with ships' models in wind tunnels (wind force 70 knots) proved that an empty vessel veered of 46°, and the force on the cable was 93 tons. In same weather condition fully laden vessel veered 18° only, with the 24 tons force on the anchor chain (75% less, than in ballast!).
11. With a trim of 3 feet (0.9 metre) by head fully laden, as well in ballast condition vessel has experienced a yawing of 5° only. That time forces in the cable have been reduced practically to zero.

Apart the question how to trim by head the modern bulk carrier being in ballast condition, and additionally keep all her ballast tanks full, personally I prefer do not keep the vessel with such trim, particularly in the most severe weather conditions, as is hurricane.

O.K. the angle of yawing, and the forces on the anchor chain are much, much decreased, but in the case the cables are parted the vessel with trim by head is practically not under command!

It also must be taken under consideration, that all bulk carriers and tankers have the superstructure aft, which is acting as big sail (mizzen). Usually they are not powerful vessels. The high freeboard when in ballast makes them difficult to manage in strong wind conditions.

(IV)

MINIMIZING OF THE SWINGING AREA

General Remark

If vessel is anchored at one anchor only, she requires room for swinging around. For the practical purposes, we can say that the diameter of turning area is the sum of the length of the vessel, length of the anchor chain that is being used, and safety reserve needed for dragging the anchor during turning around. See figure 29. The safety reserve for dragging depends mostly on the bottom characteristics (holding ground), the weather conditions, and type of anchor.

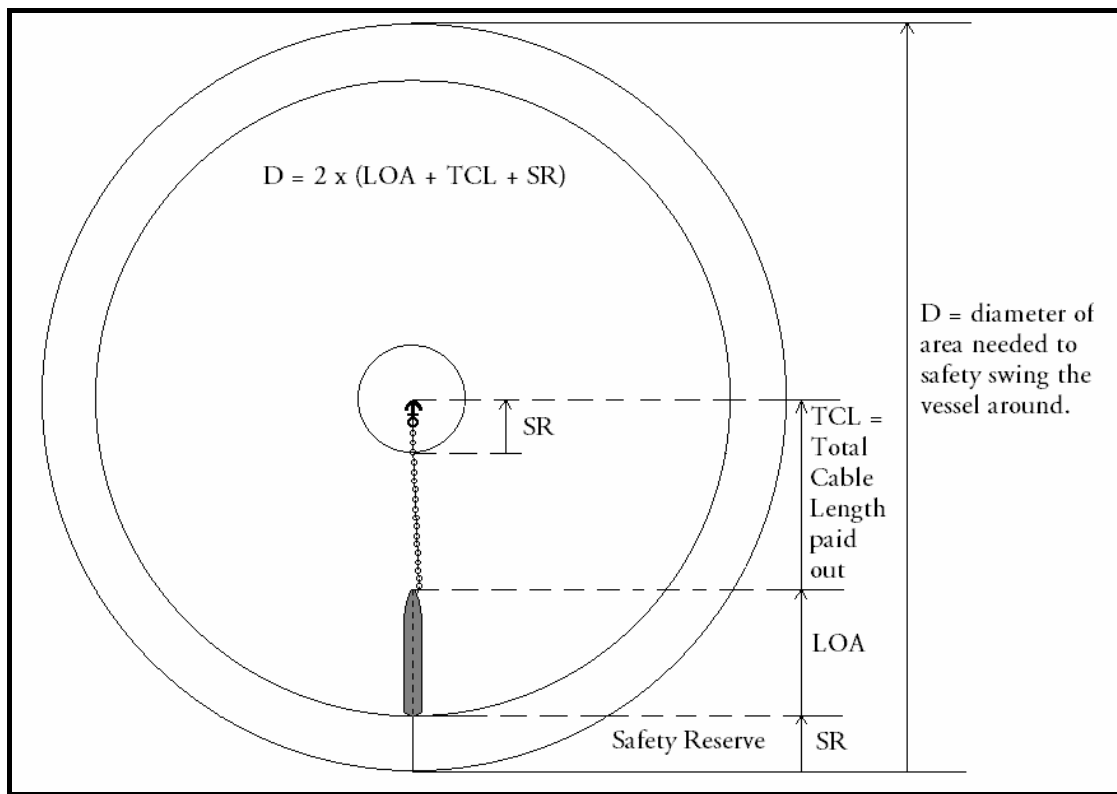

Fig. 29. Swinging room required at single anchor.

Exactly diameter of swinging room we can calculate from the formula:

$$D = 2 \times L + \sqrt{(TCL)^2 - h^2} + SR$$

Where:

D - diameter of swinging room,

L - length of the vessel from the hawse pipe to the stern

TCL - total cable length paid out,

H - distance from the hawse pipe to the seabed,

SR – safety reserve (which depends mostly on: speed of the vessel when dragging the anchor, frequency of checking anchor position, and the Main Engine notice).
In the case the swinging area is limited, the use of two anchors becomes necessary, see figure 30.

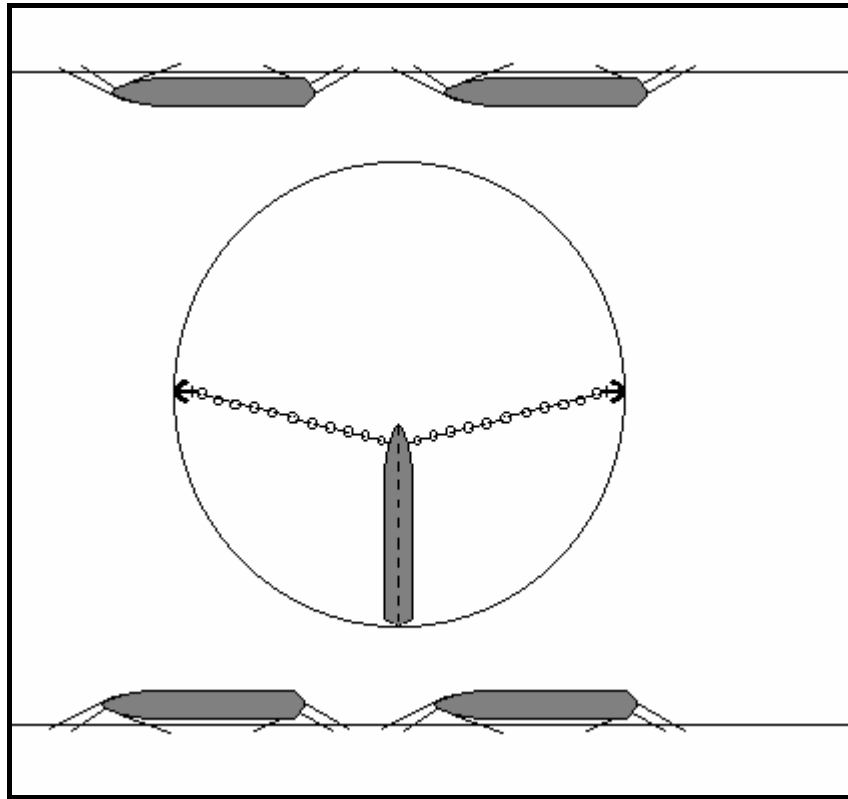

Fig. 30. Swinging room required with two anchors dropped.

The Standing Moor (Dropping Moor, Ordinary Moor)

This manoeuvre is used mostly in the rivers where is the influence of the tides, and during the tide change vessel must be swung of about 180° , but there is not enough space to do so at one anchor. See figure 31.

The Standing Moor is generally used in case the tide current is strong.

In a weak stream it is probably necessary to use the main engine astern after letting go the first (upstream anchor). It will swing the vessel out of the direction of the tide due to propeller transverse thrust effect.

The Standing Moor is carried out as follows:

1. The vessel is steaming slowly against the tide and both anchors are ready to immediate use.
2. In the distance of about one ship's length upstream to the planned anchor position, the main engine is stopped.
3. When ship is stopped, and starts slight sternway with the tide the first anchor is dropped.
4. The cable is veered until the amount of shackles paid out is equal to the double distance to the desired (planned) anchoring position.

5. The first anchor windlass is put in the gear, and the cable is commenced to heave up.
6. When the vessel begins move ahead against the tide, the second anchor (downstream one) is dropped and its chain is paid out simultaneously with heaving up the first anchor cable.
7. The ship is finally anchored in the middle between the anchors with equal cable length on each anchor.
8. If it is known that wind, or tide current will be stronger from one direction than from the other, little a bit more cable is laid out from this direction. Under the normal conditions more the anchor chain is paid out upstream the river, because the river current is strengthened by the tide periodically, and therefore the ebb tide is stronger than the flood.
9. In the case there is wind blowing across the line of tide current, the first anchor dropped must be from the lee ship's side, otherwise the cables will be crossed when the vessel is brought up.

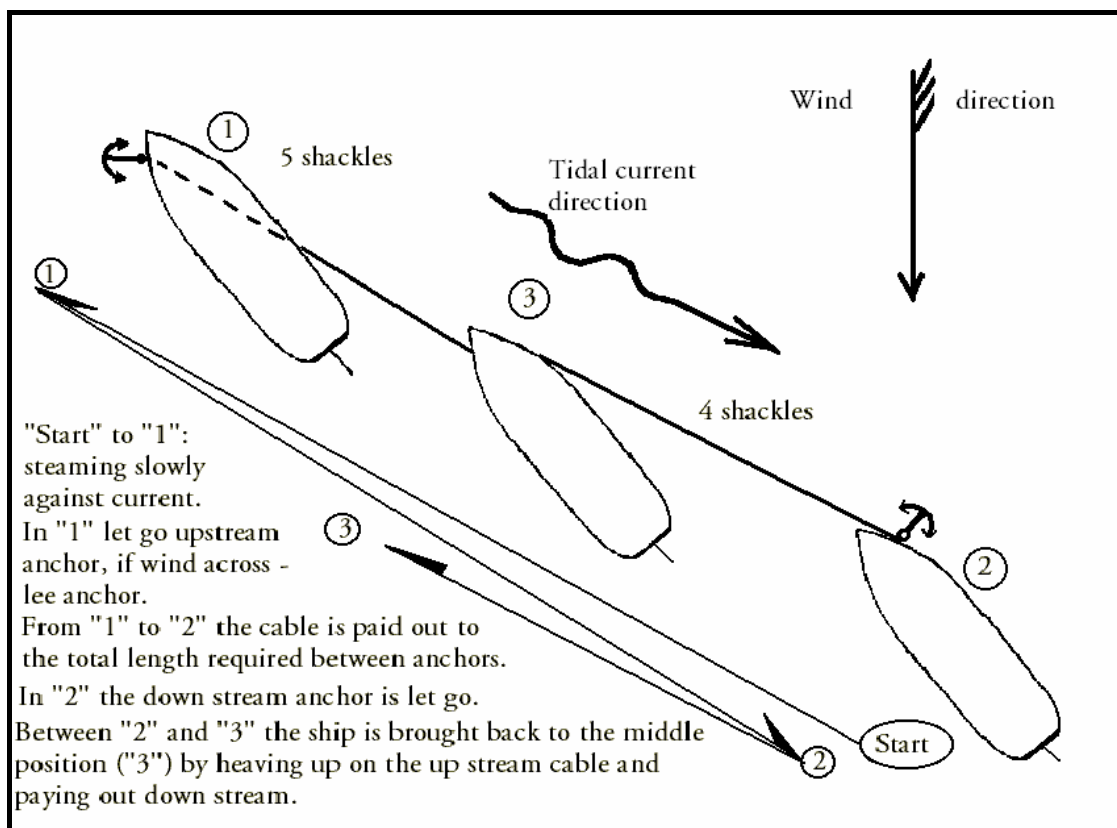

Fig. 31. The Standing Moor Sequences.

There are some disadvantages connected with this type of anchoring:

1. On each anchor can be used only about half of the total length of anchor chain fitted. If the vessel has for example 11 shackles of cable on each anchor, about 5 shots on the winch may be paid out safely, not more.
2. There is severe strain in the anchor cables when strong wind is blowing across the line of the chains. Such tremendous forces are unavoidable, and therefore it is very easy to drag anchors, and put the vessel in the danger, due to lack of safety berth for any manoeuvre.
3. The cables may be fouled if the ship swings wrong way during the tide change. In order to avoid crossing the cables the main engine, and the steering

gear should be ready to use before turn of the tide. By putting the rudder hard over towards the sleeping (not working, downstream) cable and use the engine appropriately just before slack water the correct sheer is given to the vessel.

4. The clearing of the fouled anchors could be possible by disconnecting the sleeping anchor chain.
5. The next step is to pass outboard end of disconnected anchor chain around the riding cable and then bring it back through the hawse pipe.
6. This is not simple operation, particularly with not trained crew.
7. In the worst condition when the anchor cables are crossed few times around the assistance from the hired tug is necessary.

Departing from the “Standing Moor”.

When leaving the anchorage one cable must be slacked away while the second one is heaved up. Having the first anchor aweigh, we can start to heave up the second one. The last anchor heaved up should be that one which is leading towards the direction of departure. Ideally if this anchor is the riding anchor. Sometimes is better to wait a couple of hours for change of tide and leave the anchorage directly without stresses and possible problems when turning the vessel of 180° at relatively small area.

The Running Moor

This is an alternative manoeuvre to the Standing Moor, and the final effect is exactly same. See figure 32.

The Running Moor is more often used than the Standing Moor, particularly when the tide current is weak. The better control of the ship's behaviour and less time used to carry out is the main advantages of this manoeuvre.

In my sea carrier this type of anchoring at 2 anchors was used for example in 1984 (M/v "Jozef Wybicki", POL) in Whampoa (presently Huangzhou Port), Zhu Jiang River, China.

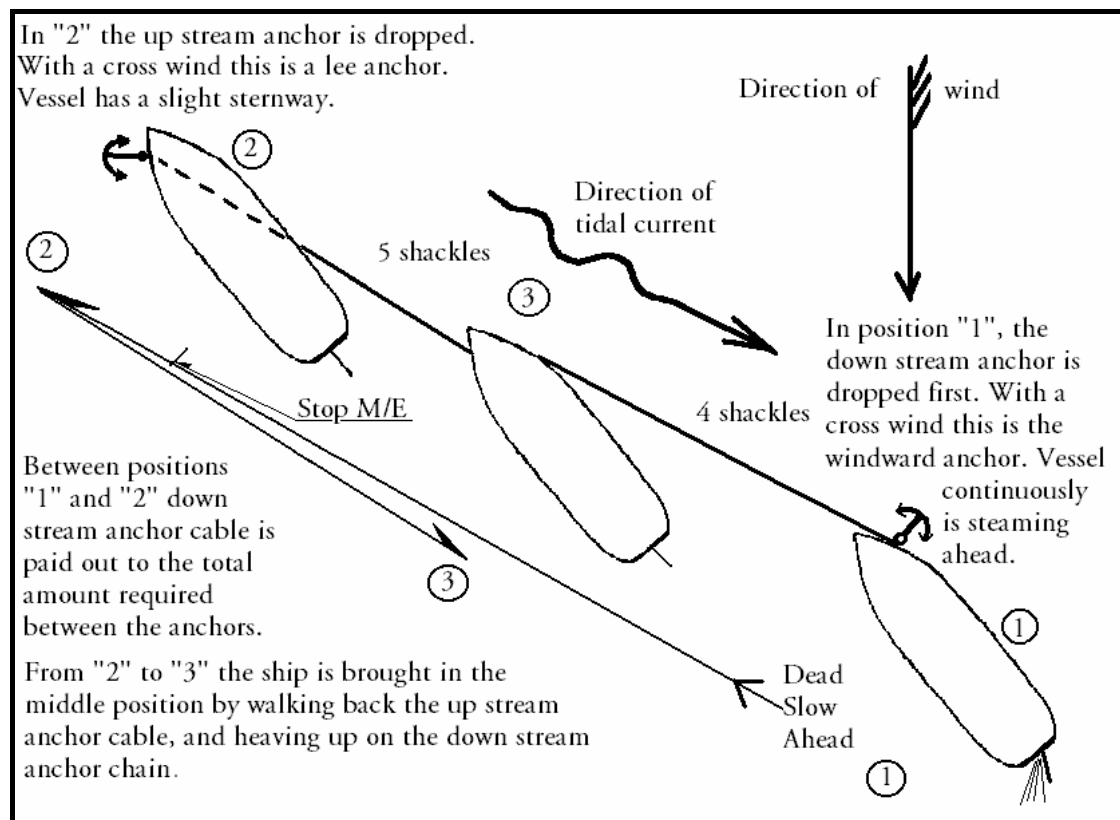

Fig. 32. The Running Moor Sequences.

The Running Moor is carried out as follows:

1. The vessel is steaming slowly against the tide and both anchors are ready to immediate use.
2. In the distance of about one ship's length down stream to the planned anchor position, the first anchor is dropped (fig. 32, position 1). With the cross wind this is the windward anchor.
3. The vessel is moving ahead against the tide continuously, and the first anchor cable is veered until the amount of shackles paid out is equal to the amount required between the anchors (the double distance to the desired anchoring position).
4. In the appropriate distance to the position 2 (maximal up stream) the main engine is stopped.

5. When the vessel is stopped, and starts slight sternway with the tide the second anchor is dropped (in position 2). With the cross wind this is the lee anchor.
6. The first (down stream) anchor windlass is put in the gear, and the cable is commenced to heave up.
7. Same time the chain of the second anchor (up stream one) is paid out simultaneously with heaving up the first anchor cable.
8. The ship is finally anchored almost in the middle between the anchors with equal cable length on each anchor (position 3).
9. As it was mentioned before under the normal conditions more cable is paid out of upstream anchor, because the river current is strengthened by the tide periodically, and therefore the ebb tide is stronger than the flood.
10. In the case there is wind blowing across the line of tide current, the first anchor dropped must be from the windward ship's side, otherwise the cables will be crossed when the vessel is brought up (note this is just opposite than in the Standing Moor!).

The Open Moor

The idea of the Open Moor is shown in figure 33. The both anchors are sharing the strain, and an angle between the anchor cables vary between 45° and 90°. Such angle assures appropriate restriction of yawing, minimizing of the swinging area, and lessening the strain in the individual cable. The best angle is of about 60°.

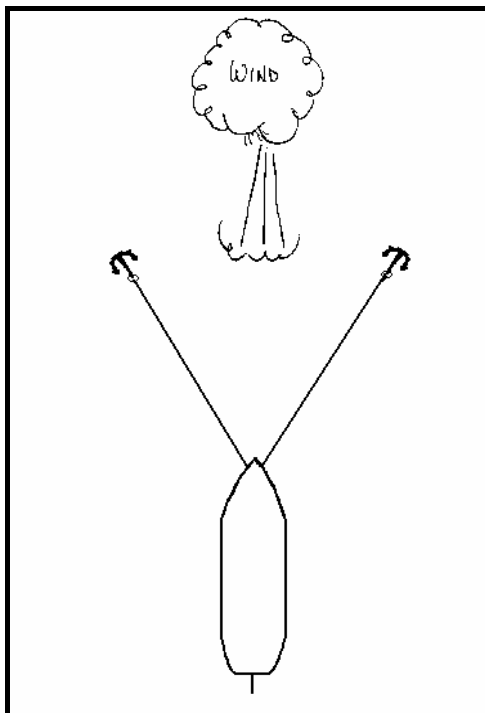

Fig. 33. The "Open Moor".

There are few ways to carry out this manoeuvre, but always the first anchor is dropped while the vessel is still moving ahead.

The first most popular method is as follows.

If the vessel is approaching to "The Open Moor" from the starboard side (see Fig. 34) the starboard anchor is dropped first. The vessel is approaching the anchorage with the wind and / or current on starboard quarter (position 1).

The weather, in this case starboard anchor is dropped in the moment the ship is passing the position marked "2", and is gradually swinging to starboard. This anchor brake is kept open.

Due to the weight of the anchor cable, slow speed and the wind (and / or current) influence the counteraction of lee drift / current setting is necessary.

To do so the wind and current are kept on the starboard bow (position 3).

Please note that due to the weight of starboard side anchor cable the vessel may swing rapidly to starboard, therefore the rudder must be used accordingly.

Approaching to the position 4 all headway is taken off by putting the main engine astern.

Meantime the first anchor cable is most probably leading more, less at 7 o'clock and medium tight, and now its brake is made fast.

When the vessel has commenced coming astern the port side anchor is dropped.

Coming astern assures the anchor will dig in, and the anchor cable does not foul the flukes. While going astern the second anchor cable (in our case port side) is paid out.

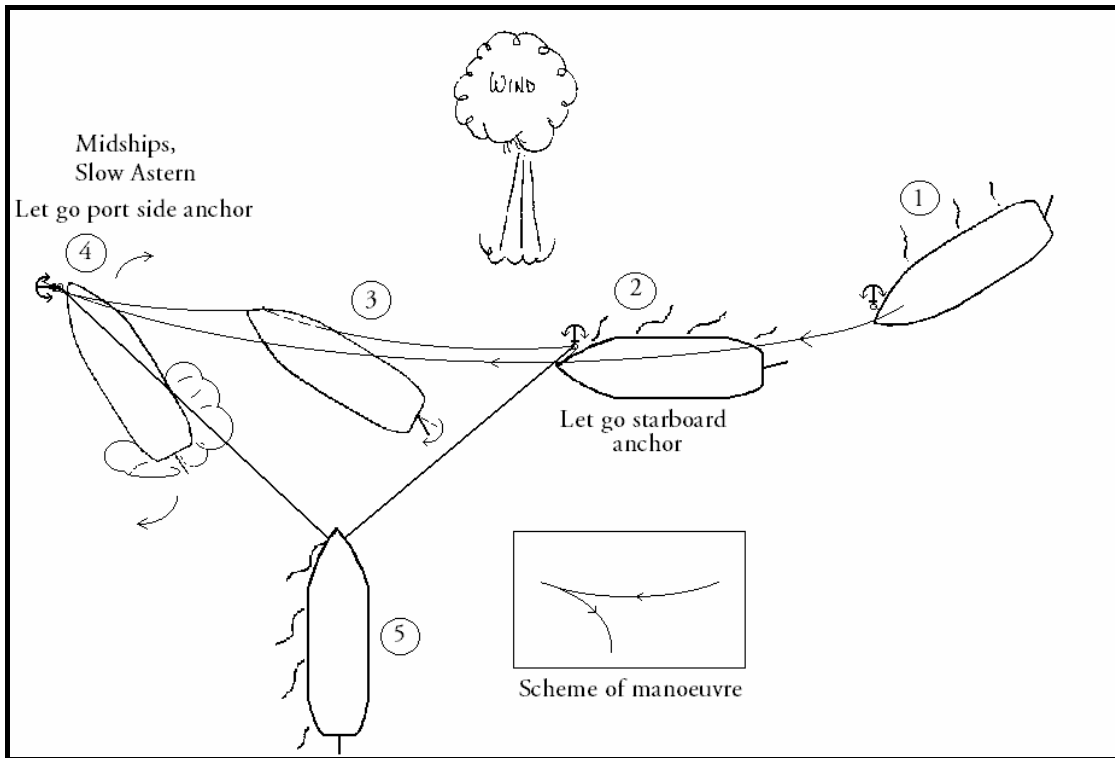

Fig. 34. Approaching to "The Open Moor" from the starboard side.

Under the tension of starboard side anchor cable, wind / current force and transverse right hand propeller thrust the vessel is swinging to starboard rapidly. Finally she is stopped in position 5, which one is the apex of the triangle formed by her two anchor cables.

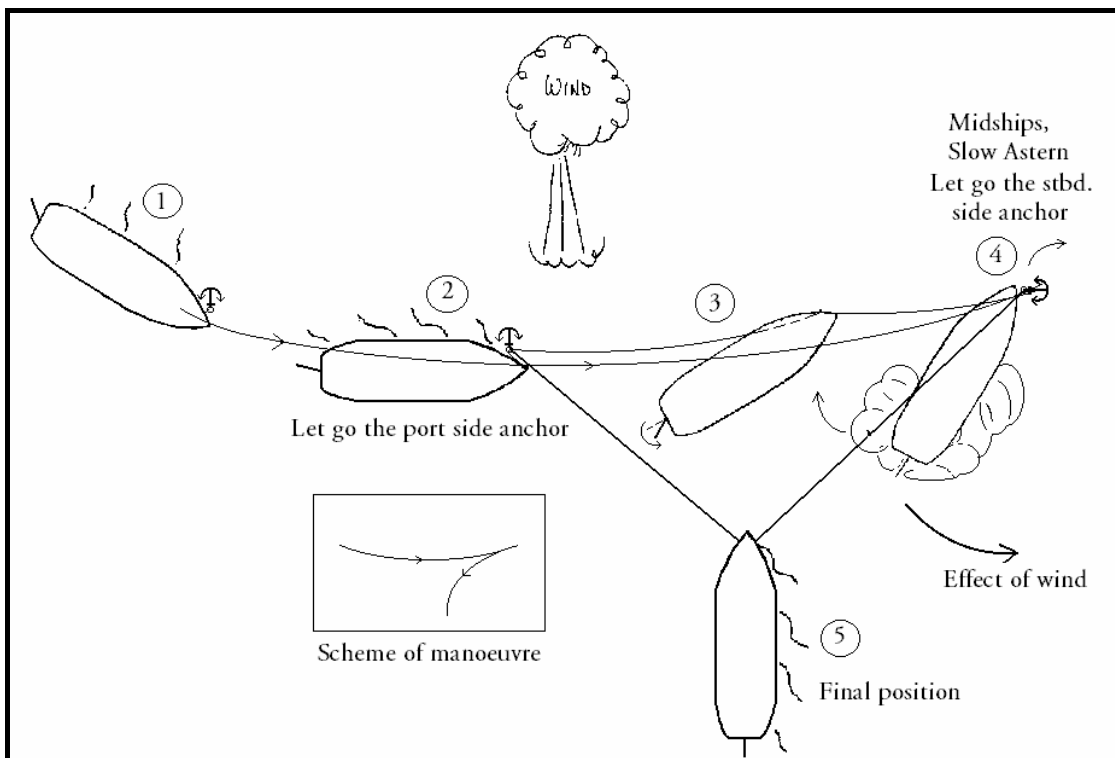

Fig. 35. Approaching to "The Open Moor" from the port side.

The vessel is moving ahead until she reaches the position 2, which is situated approximately in distance of one-third of the final length of the anchor cable. Then the first anchor windlass brake is made fast, and shortly after the second anchor is dropped.

As the weather anchor cable becomes taut the ship's bow is swinging towards the eye of the wind, or up to current (position 2).

With the main engine working still ahead, and the rudder put towards the wind / tide direction (to the weather side) the ship is rapidly turning into the stream or wind.

By keeping a little a bit ahead of her anchors with both cables leading slight aft (position 3) the manoeuvre is accelerated.

With the vessel heading towards the wind or current, the main engine is stopped, and the rudder put midship, then slow astern revolutions on the main engine are applied for the while. When the ship has commenced movement astern both anchor chain cables are paid out until the ship is reaching the final position (4).

General remarks.

The vessel moored in this way is not intended to turn around as she would at a single anchor or at a "Running / Standing Moor". In the waters affected by strong tidal currents the vessel should heave up one of the anchor shortly before the slack water, and drop it again after change of tide current direction, otherwise both anchors will be fouled.

It must always be kept in mind that the anchors and cables laid too far apart are weaker than a single anchor. With very strong wind the experience has proven that after the lapse of time both anchor cables start drag and are pointed almost straight ahead, because have been pulled towards each other. Situation becomes similar to "Riding to Two Anchors", and the vessel has the best possible security from two anchors.

The Parana River Anchoring

Manoeuvring in the Rio Parana has its own peculiarities. Typical peculiarity is lack of tugs and therefore common use of anchor during berthing even large vessels as for example "Panamax" type.

Another distinctive feature is way of anchoring the vessels at two anchors. The anchorages are narrow, very close to the riverbank. There is lack of swinging room, but due to incessant down-river flow of about 3 – 4 knots the vessel will always remain current ridden.

As it was observed vessels are anchored in distance of about 2 cables to the vessel ahead, and 3 cables to the vessel being astern. To the nearest riverbank is the distance of about 1.5 cables only.

This anchoring is something between the "Running Moor" and the "Open Moor".

The particular steps of approach and dropping the anchors are showed in figure 37, as have been observed and noted at San Marin Y San Lorenzo South and North Roads in June 2001.

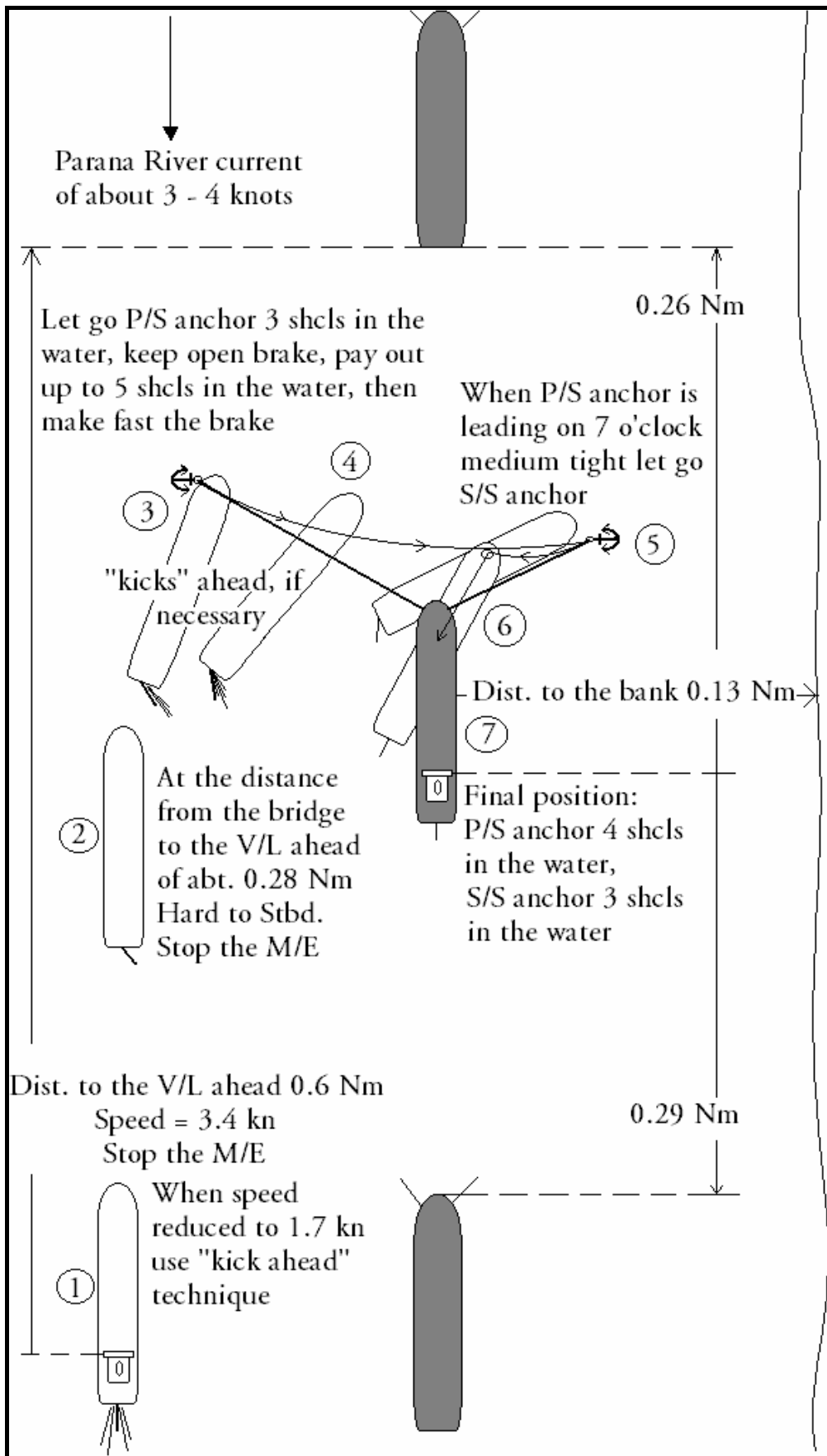

Fig. 37. Anchoring the vessel in Parana River for shorter period of time.

Position 1.

The vessel is steaming up the river against the current. When she has speed of about 3.5 knots the main engine is stopped. That time she has on her beam a vessel which will be astern after dropping the anchors. To the vessel ahead are about 5 – 6 cables. If the speed is reduced to about 1.7 knots (because of current), or the vessel doesn't answer the helm properly "kick ahead" technique is applied.

Position 2.

When the distance from the bridge (exactly the radar antenna) to the vessel ahead is reduced to about 0.25 - 0.3 cables the rudder is put hard over towards the nearest riverbank, and the main engine stopped, if worked before.

Position 3.

When the vessel has commenced swing and the distance to the vessel ahead is reduced to about 2 cables the anchor from the opposite side to the ship's swing (in our example port side anchor) is dropped, 3 shackles in the water. The brake should be open.

Position 4.

If necessary "kicks ahead" together with the rudder hard over are used.

Position 5.

With five shackles on the first anchor cable already paid out the windlass brake is made fast.

When the cable is leading at 7 o'clock, medium tight and the bow becomes swing towards the first anchor, the second anchor is dropped.

At same time the first anchor windlass is put in the gear (engaged) and the anchor cable hove in to 4 shackles in the water.

Finally the vessel is anchored with 4 shackles of cable in the water on the first anchor, and 3 shackles in the water on the second anchor.

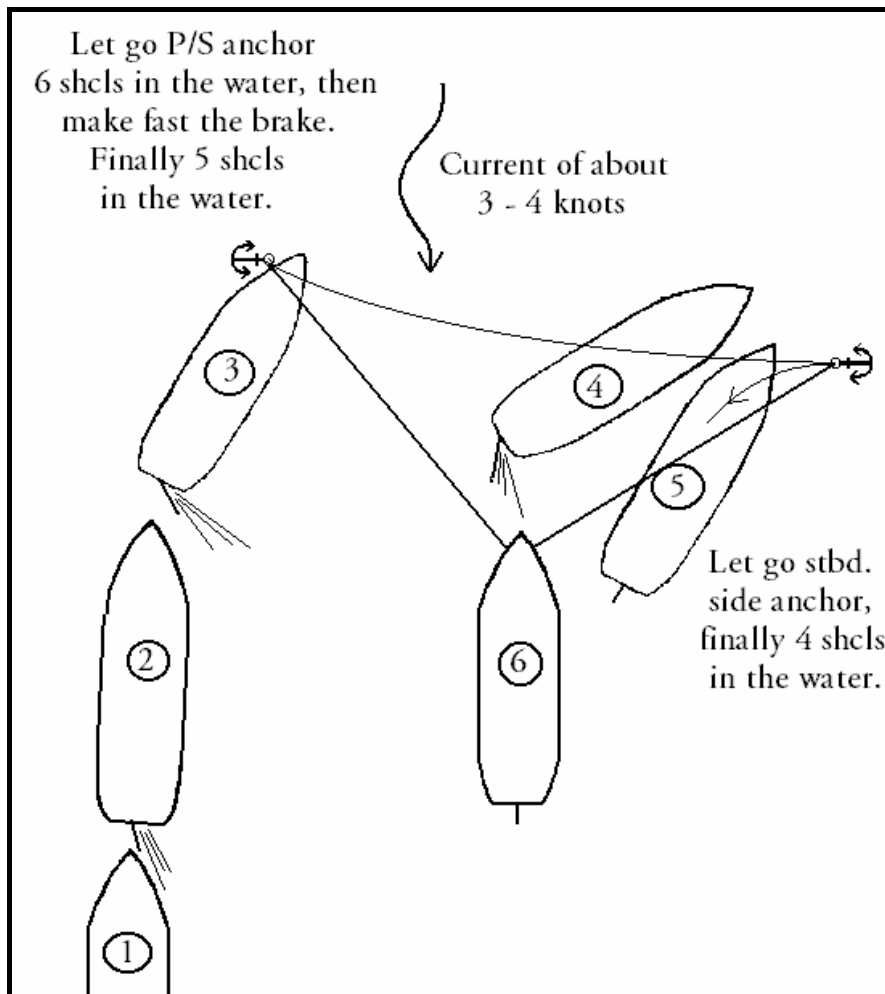

Fig. 38. Anchoring the vessel in Parana River and waiting for free berth.

The main difference between dropping the anchors for shorter and longer period is the amount of anchor cable shackles used. The four on one and three shackles on the second anchor are used in case the vessel is scheduled to berth shortly after boarding of the officials and getting the “free pratique”.

If the vessel has to wait for free berth longer one shackle more is added to each anchor cable as it seen in figure 38.

The leading of both anchor cables in good weather condition is well seen in the figures 39 and 40.

As it was mentioned before this way of anchoring is something between the “Running Moor and the “Open Moor”. In this particular case the advantage of such dropping the anchors is appreciated when strong winds are blowing from the ship’s quarters. With such winds the vessel is moving ahead, but still remains current ridden. Both anchors are leading astern; windward cable is taut, and leeward one up and down, partly under the vessel’s hull (see figure 41).



Fig. 39. "Panamax" type vessel anchored in Parana River – San Nicholas.



Fig. 40. "Panamax" type vessel anchored in Parana River – San Martin y San Lorenzo North Roads.

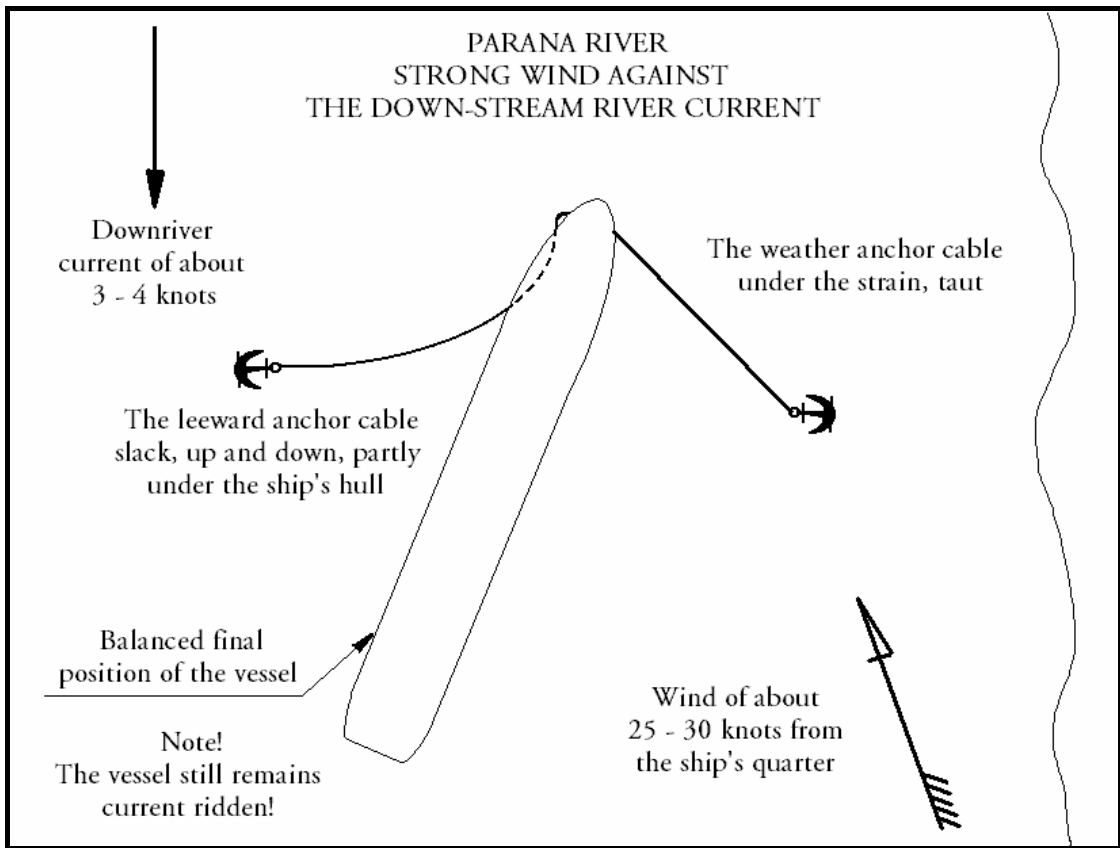

Fig. 41. Positioning of the vessel in the Parana River when strong winds are blowing from the ship's quarters.

The Mediterranean Moor

This is the variation of the Open Moor, but used in the port to make fast the vessel's stern on to the berth while her both anchors are leading ahead, and holding the bow in position perpendicular to the quay (Fig. 42).

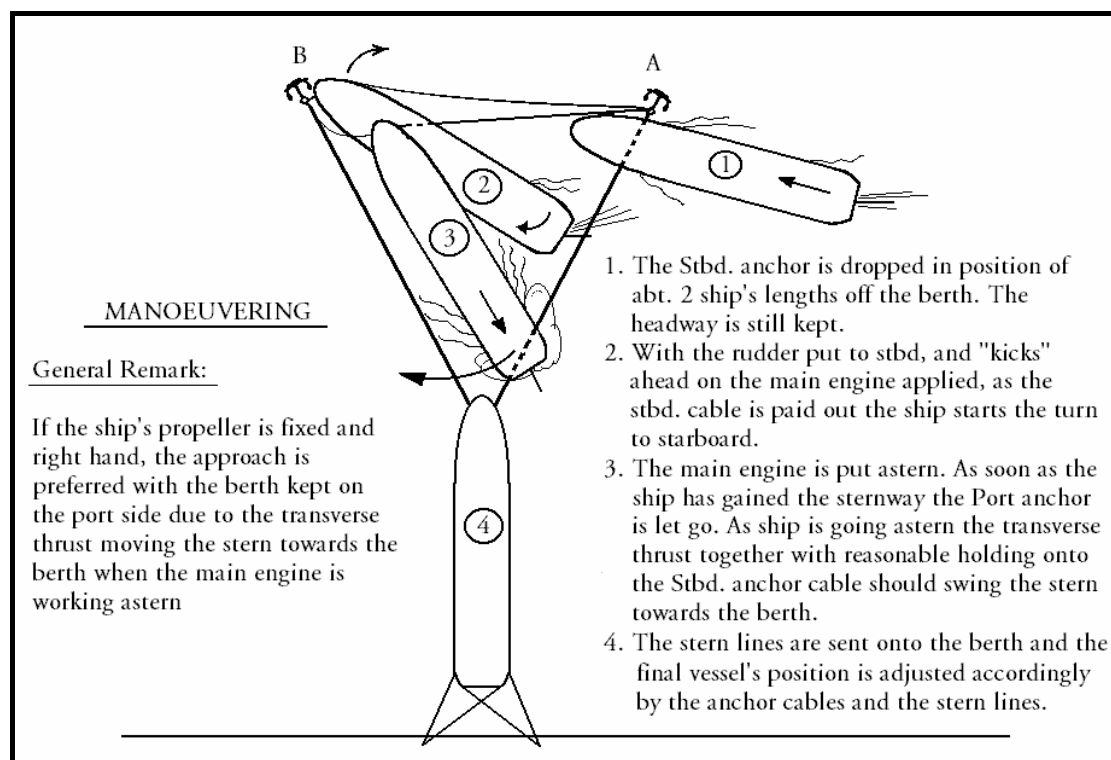

Fig. 42. Mediterranean Moor.

This method of berthing was used commonly in the last decades in the Mediterranean Sea area, particularly for small vessels, in ports where the berth space is limited. Presently is used generally to berth the ferries and Ro-Ro vessels.

If the vessel is equipped with right hand fixed propeller the approach is preferred with the berth kept on the port side due to the transverse thrust moving the stern towards the quay when the main engine is put astern.

Keeping the vessel almost parallel to the berth with small headway still maintained makes the approach. In the distance of about two ship's lengths off the berth, while passing the position indicated "A", the starboard (offshore) anchor is dropped. With the rudder put to starboard, and applied "kick" ahead on the main engine the ship starts the turn to starboard (from the berth). The offshore (in our case starboard) anchor chain is paid out almost until reaching the position marked "B", and then made fast. The main engine is put astern, and as soon as the vessel has gained the sternway the port (shore side) anchor is let go.

The transverse thrust of the right hand propeller, and reasonable holding onto the starboard anchor (the first dropped) will cause the vessel to move astern towards the berth. Meantime the anchor cable of the second anchor is kept comparatively slack. The stern lines are sent onto the berth as soon as possible by the mooring boat, or the heaving lines.

Usually the first stern lines being sent ashore are making the letter "X" (see fig. 42). Anchor chains and the stern lines adjust the final vessel position accordingly.

The Conventional Buoy Mooring (CBM) – berthing /unberthing large tanker to and from the Sea Berth

This is another variation of the Open Moor, used in the open sea to make fast the large tanker's stern on to several mooring buoys with her both anchors spread leading ahead to hold the bow in required position in order to connect the loading hoses to the ship's manifold. See figure 43.

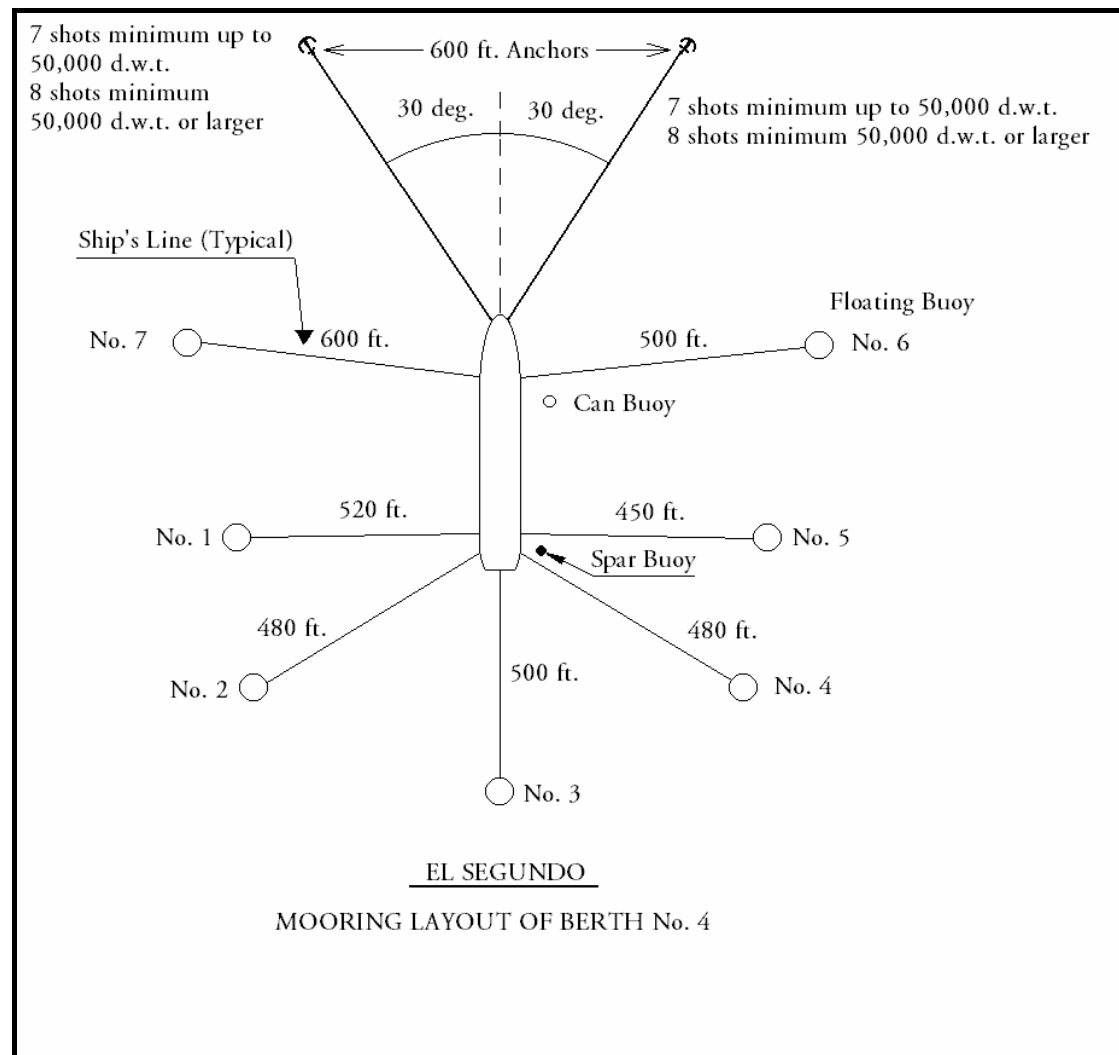

Fig. 43. Mooring layout for the tanker vessel in CBM, El Segundo, USA.

The Mooring Master(s):

The pilot who is the master's adviser in berthing / unberthing operations, and in fact he is in charge of these manoeuvres is called the Mooring Master.

Two Mooring Masters are very often provided. They are boarding the tanker 1 to 2 miles off the sea berth. One is in charge of piloting and the second, with less seniority, is on deck advising the officers and crew performing the mooring operations.

To the Mooring Master responsibilities and duties belong:

- Evaluating the vessel's equipment (anchors, mooring lines, cargo booms, deck winches, fairleads, bits, etc.).

- Ensuring that all necessary preparations for mooring have been made (both anchors clear and ready to drop, mooring lines properly placed, power on deck mooring winches, wrenches, snatch blocks, stoppers, etc. laid out and ready).
- Describing with sketches the planned course of action to moor the vessel, to the Master and Deck Officers who will be involved.
- Manoeuvring the vessel into the mooring area.
- Directing the dropping of the anchors and running the lines to the mooring buoys.
- Controlling the actions of the tugs (if any), and the mooring launches during mooring operations.
- Directing the adjustment of the anchors cables and mooring lines, so that the vessel is properly positioned in the berth.
- Directing the taking in the mooring lines, and heaving up of anchors.
- Controlling the actions of the tugs (if any), and the mooring launches while unmooring.
- Piloting the vessel safely clear of the moorings.

The typical mooring sequences

1. Making the approach to the CBM

The vessel approaches the mooring, steering on the “approaching range line”, leading to the mooring buoys.

In order to mark the position where the first anchor should be dropped another range line, crossing with the above line is set (for example in Italy, at Quiliano Terminal). Sometimes a small marker buoy has been established to assist the Mooring Master in placing the first anchor in the correct position (United Arab Emirates, Jebel Dhanna – Sea Berths Terminal).

A spar buoy that is provided to mark the position of the subsea manifold, in some terminals together with the drop target is used to indicate the second leading line. The intersection of the “drop target – spar buoy” line and the approaching leading line determines position of dropping the first anchor (see figure 45).

These two leading line marks, or the approaching range line and the marker buoy are set out for a vessel of specific tonnage or length.

The larger vessel then specified must drop her anchors farther out in order to pay back same amount of anchor chains as it is required, and therefore making the approach to the CBM must keep the leading marks open.

As the opposite to the above the smaller vessel, or ship being short of anchor cables must steer inside of the leading lines, and keep the marks open to the other side.

See also figure 44.

Due to influence of wind and current the vessel’s heading differs from the leading line.

We have to keep in mind; the windage area of the VLCC being in light condition is of few thousand square metres, therefore the appropriate correction for drift must be applied in order to drop the anchors in the right position.

To understand how does such huge area affect the behaviour of vessel, let make simple calculation.

The wind of speed of 30 knots is acting with force of about 12 tonnes on vessel with 1000 square metres windage area.

On the VLCC of let say 6000 square metres area same wind gives the Total Wind Force of about 72 tonnes, what would require large angle correction in course for drift, or a combination of tugs that offer a total bollard pull of at least 72 tonnes.

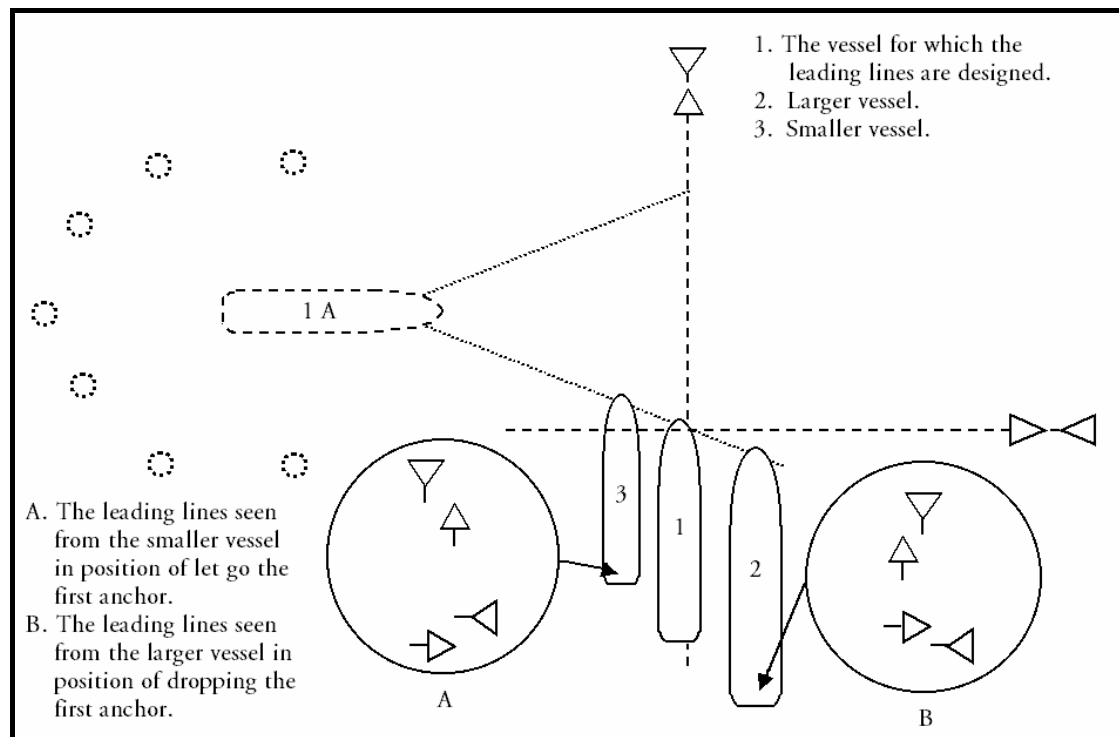

Fig. 44. The leading lines seen from the different size vessels in the position of dropping first anchor.

The bridge on the modern VLCC is situated few hundred metres aft from the hawse pipes, and the Mooring Master seldom see the leading marks in line.

As it is seen in figure 45 the bow (exactly the hawse pipe of the outer anchor) should follow the leading line, therefore proper advice given from the forecastle is invaluable.

If the wind is onto the mooring buoys the Mooring Master at the bridge see the leading marks, as he would be on board of smaller vessel then specified.

But if the wind is blowing from the mooring buoys side the situation is just opposite. Both cases are shown in figure 45, and are self-explanatory.

If the vessel's track over the ground is chosen correctly, both leading marks should be seen from the fo'c'sle (just close to the hawse pipe of first dropped anchor) in one line.

The ship's pivot point should follow the parallel line to the leading line, and must be kept in mind in order do not to overshoot the marks.

This is important especially when rudder is used for speed reduction ("Fish Tailing" or "Rudder Cycling" method).

For the vessel with right hand fixed propeller easier is approach from the starboard side due to the effect of transverse thrust, which helps to swing the stern towards the mooring buoys.

But for the sake of clear, approach to the CBM depends on the terminal, local sea bed configuration, weather condition, sea state, vessel's size, her draft, loading / ballast

condition, limitations of the ship's mooring gear, availability of the tugs, and of course the techniques used by the Mooring Masters.

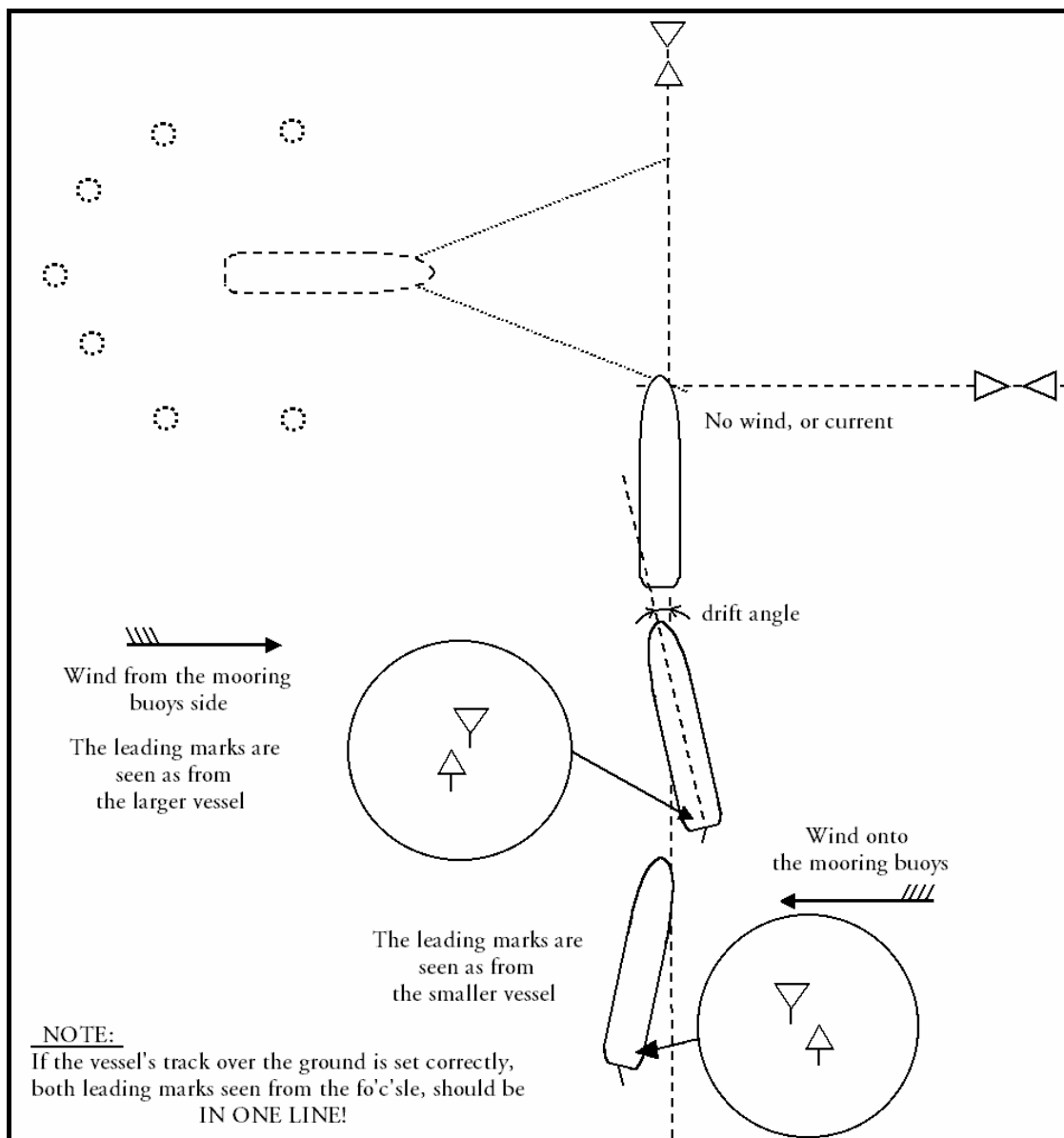

Fig. 45. The leading marks seen from the bridge of vessels of the same size when the appropriate correction for wind drift, or current setting is applied.

2. Dropping the anchors

Depends on the approach direction port, or starboard anchor is dropped first at the point indicated as "A", and usually 8 to 9 shackles of chain is paid out on the run, chain is then held.

This is very important that the first dropped anchor must let go freely with the brake kept well open, until at least four shackles of anchor chain are out, and good horizontal pull on this anchor is achieved.

With smaller amount of anchor cable paid out the anchor will drag.

When the first anchor chain is fetches up leading aft, the second anchor is dropped at point marked "B"

3. Working into the berth.

Ship's stern is worked into berth as first cable is held and the second chain is paid out approximately 8 shackles, and the lines are run to the mooring buoys.

Then both chains are adjusted as necessary to position the vessel properly in the berth. The angle between the anchor chains depends on the terminal, and varies between 60° and 90° (it means 30° to 45° between each cable and fore and aft ship's line).

Wind and current will largely govern which mooring lines are sent first, and under normal circumstances this is the Mooring Master decision which mooring lines are run out first.

The detailed procedures are modified to fit conditions of the particular berth, wind, current, sea state, vessel's size / loading, limitations of the ship's mooring gear, and the techniques used by the Mooring Masters.

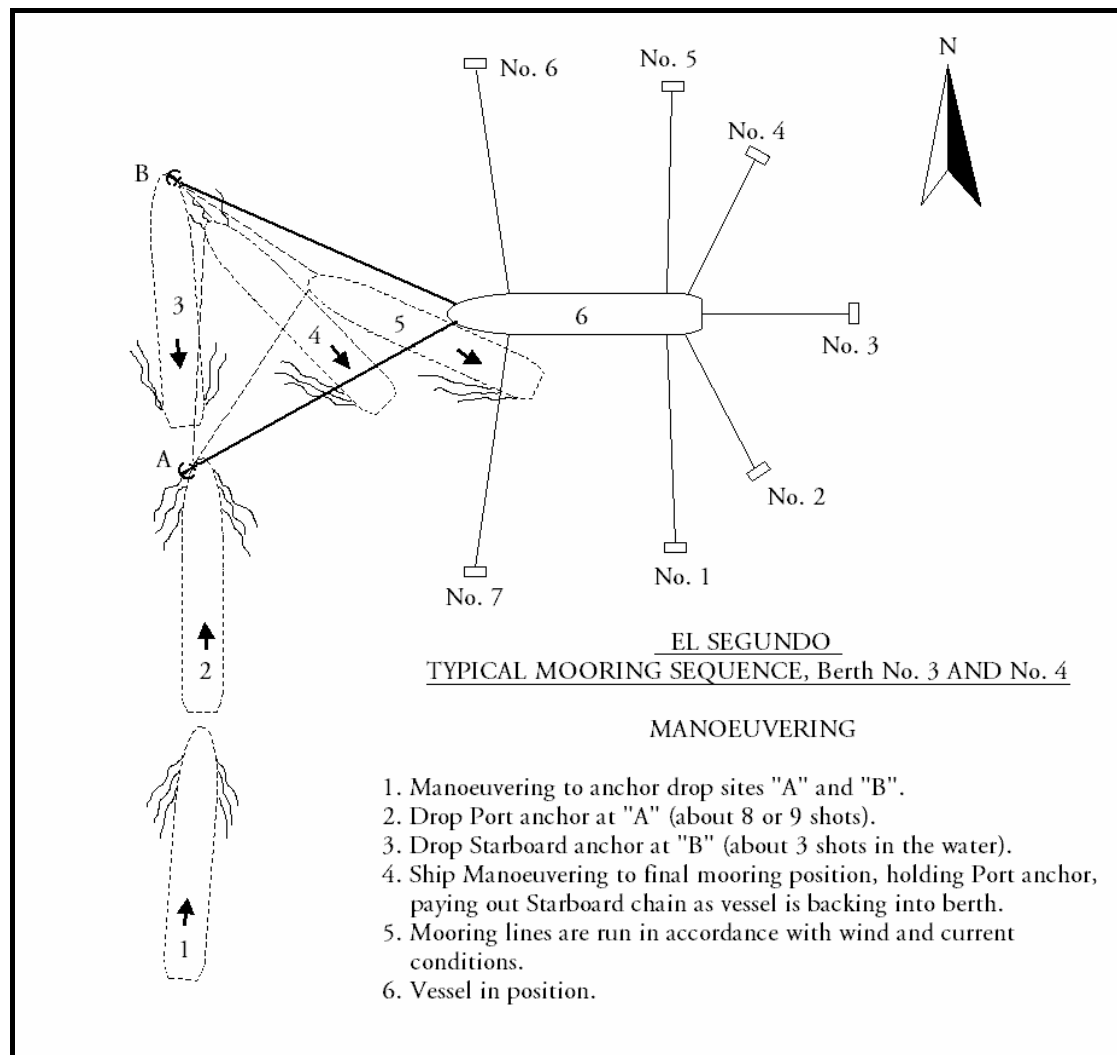

Fig. 46. Approaching to the CBM from the port side and typical mooring sequence in El Segundo Terminal, Berth No. 3 and No. 4 (U.S.A).

The typical mooring sequences with approach made from port and starboard side are shown in figures 46 and 47.

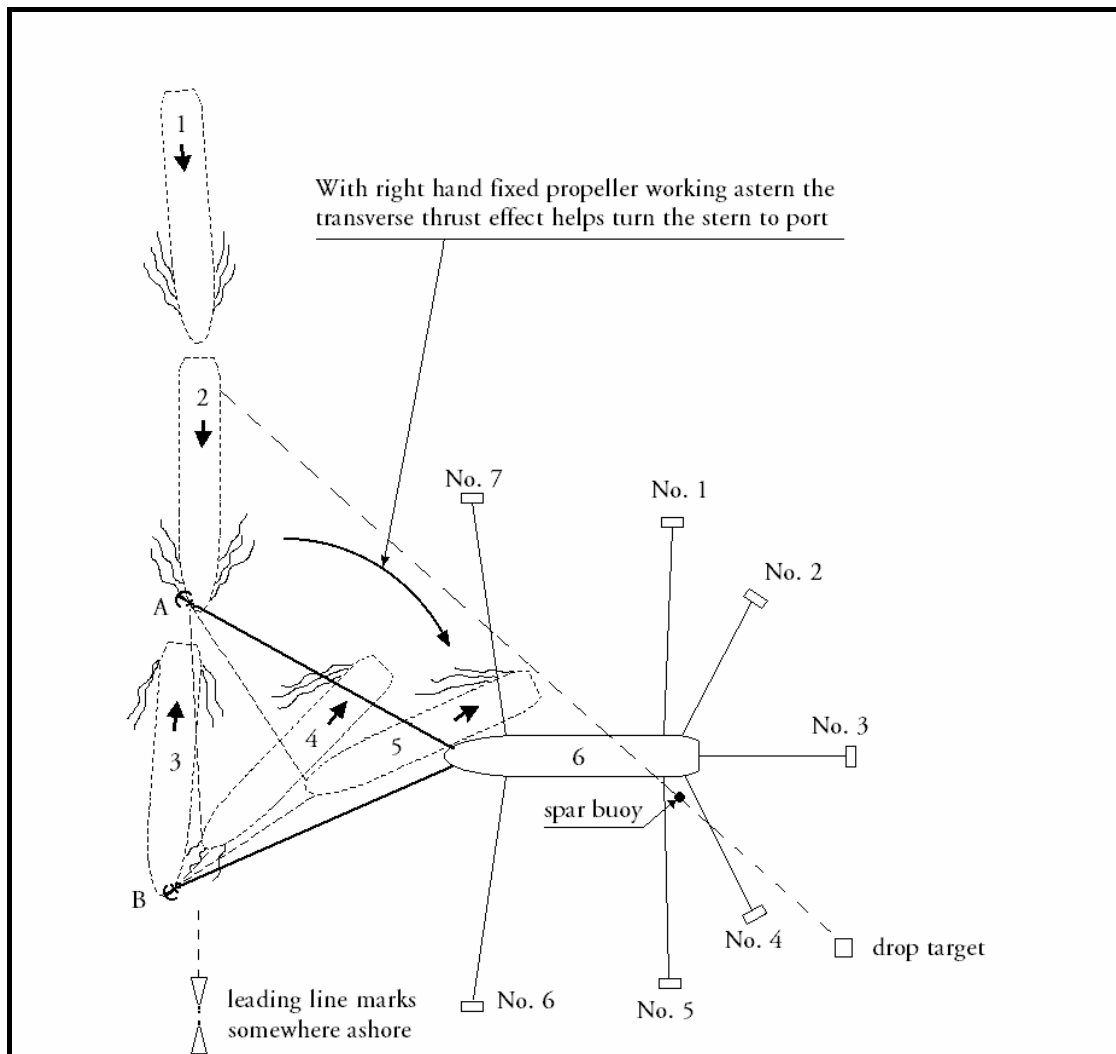

Fig. 47. Approaching to the CBM from the starboard side and typical mooring sequence (for comparison with fig. 46).

CBM: principles of factors and forces acting during berthing / unberthing

Introduction

In some terminals where the tugs are still not available (for example Sidon, Lebanon) berthing and unberthing of large tankers is the classic form of the ship handling art. But if tugs cannot be used there are some restrictions.

At Sidon Zahrani Oil Installation and Sidaco Terminal berthing and unberthing are carried out during daylight hours only, and vessels must not arrive with more than 50,000 tons cargo on board.

Tankers up to 80,000 DWT or approximate 55 feet (16.76 m) draft are considered maximum size, which should be handled during winter months at Sidon.

In summertime maximum vessels size is 100,000 DWT.

The good knowledge and experience in use a strain on the anchor chain to advance when backing the ship, turning the vessel on the anchor with rudder put hard over and good "kick" ahead applied are making the necessary base to carry out manoeuvres successfully (see fig. 48).

Understanding of external forces acting on the vessel, prediction and taking into account the actual pivot point position is vital.

A good spread of the anchors and sufficient chains amount on the bottom are essential for adequate holding power.

The effect of wind during berthing and unberthing especially without tugs create a major difficulty. Lack of understanding ship's behaviour in the wind will bring very quickly situation out of control.

From other hand many objects floating around can foul the propeller, and movement of the propeller can make disaster even if one hose buoy is hit.

All it must be always kept in mind when planning these manoeuvres.

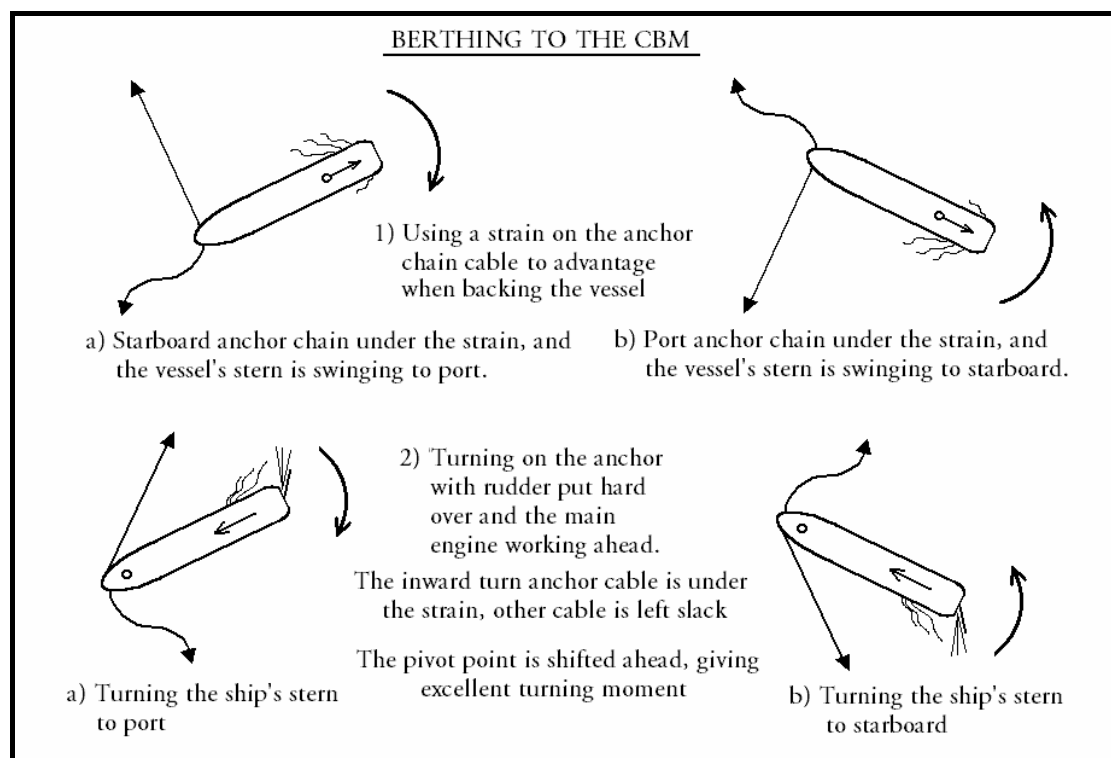

Fig. 48. Berthing to the CBM:

- a) Using a strain on the chain to advantage when backing the vessel,
b) Turning on the anchor with rudder hard over and main engine working ahead.

The anchors and Position of Pivot Point

As it was pointed before the strain on the first dropped anchor is used to advantage when backing the vessel.

If the anchor cable is leading more abeam better swinging moment has been developed. From the other hand strain on the anchor chain leading almost straight ahead gives practically no turning effect, however holding on this cable will reverse the vessel's movement.

To back the vessel towards the mooring buoys, the remarks written above must be followed, therefore the chain on the first dropped anchor must be kept under the strain, and cable of the second anchor is slack.

With the main engine working astern the ship's pivot point is moving abaft of the midship, and turning moment being on the first dropped anchor is increased. To turn the vessel in same direction but on the second anchor the ship's headway and strain on this anchor cable are needed. If these are achieved the powerful "kick" ahead on the main engine with rudder hard over will give an excellent turning moment (see figure 48).

The Transverse Propeller Thrust Effect and Position of Pivot Point

As long as vessel has sternway and the pivot point is close ship's stern there is small turning moment for the transverse thrust of the propeller, and it should be taken under consideration when approach was made from the starboard side (with right hand fixed propeller).

But as soon the vessel will commence movement ahead, the pivot point is transferred well forward (about one third of the length from forward) and the effect of the propeller transverse thrust becomes significant.

The "Kick" Ahead and Position of Pivot Point

This situation is very similar to described under the previous point.

With sternway and the pivot point still positioned abaft of the midship even good "kick" ahead with rudder hard over is giving small turning effect because is acting on the short lever.

The headway will shift the pivot point ahead making the arm longer and it increase the effect of burst ahead immediately.

The Effect of Wind

Assuming observed vessel is fully loaded on even keel modern VLCC with superstructure aft, and wind is on her beam.

Stopped vessel:

With ship stopped, the centre of effort of the wind is situated little a bit abaft of the pivot point, and therefore turning lever caused by wind is negligible.

Making headway:

But if she is making headway, the centre of effort of the wind remains in same position, but the pivot point is moving forward creating new turning lever. Depending on the wind force ship's bow will swing faster or slower towards the eye of the wind.

Making sternway:

Situation is not so simple as before. The centre of effort of the wind remains almost in same place, but pivot point moves aft to a position more, less one quarter of the ship's length from the stern. The shift of the pivot point aft has created the opposite turning lever. This new lever should cause falling off the bow.

But due to propeller transverse thrust associated with single screw vessels, and superstructure situated aft (which is acting as tremendous aft sail) the effect of wind is less predictable. With our vessel loaded on even keel the stern partially seeks the wind. The final position of the ship will be most probably almost across the wind. To bring the stern towards the wind minimum half astern speed will be necessary.

Trim and Headway:

The vessel in light ballast condition with large trim by stern has increased freeboard forward and the centre of effort of the wind has been moved forward towards the pivot point. With slow speed ahead the bow has tendency to fall off, and ship is difficult to keep up the wind. For this reason minimum draft forward and aft is recommended, even requested especially with regards the CBM berthing.

In order to have roughly idea about such recommendations, some of them are mentioned below:

- To keep minimum draft of 2% forward and 3% of LOA aft (Parana River).
- Australia, Fremantle:
 - Vessels of 30.000 – 50.000 DWT have to keep draft forward 3 – 5 m, and aft 6.5 m.
 - Vessels of DWT 50.000 – 100.000 DWT have to keep draft forward 5 – 7 m, and aft 6.5 – 7.5 m.
 - Vessels of 100.000 – 150.000 DWT have to keep draft forward 7 – 8 m, and aft 7.5 – 8.5 m.

Trim and Sternway:

This vessel with same large trim by stern when backing has the rapid tendency to keep the stern up to wind because the pivot point is going aft, but the centre of effort of wind remains almost in same position. Due to large turning lever the bow is immediately falling off and the stern quickly seeks the wind. With the strong beam wind this is very difficult to handle such ship when going astern.

Wind Force:

During adverse weather conditions the Mooring Master and vessel's Master shall determine if it is safe to move the vessel.

A large petroleum tankers movement (let say tankers of LOA greater than 210 m) depends on the particular terminal requirements.

In the restrictions are often detailed: ship's condition (loaded / in ballast), wind direction (sector), maximum wind speed (given rather in knots).

As examples only:

1. Fremantle, Australia.

Large Tankers (LOA > 210 m)	Wind Direction	Maximum Wind Speed in Knots
Loaded	From 210 to 300 degrees	Greater than 35
In Ballast	(through West)	Greater than 30

2. Quiliano Terminal, Italy.

Maximum Safe Operating Wind Speed				
Sector / Vessel's Size	50 – 150 kdwt		150 – 280 kdwt	
1 (on the bow, 110° - 200°)	50 km/hr	27 knots	45 km/hr	24 knots
2 (on the stbd beam, 200° - 290°)	35 km/hr	19 knots	35 km/hr	19 knots
3 (on the stern, 290° - 020°)	60 km/hr	32 knots	55 km/hr	30 knots
4 (on the port beam, 020° - 110°)	35 km/hr	19 knots	35 km/hr	19 knots

The Tugs

Type of tugs:

Presently the best are the azimuth stern drive, or the tractor type tugs.

The azimuth stern drive (ASD), or “Z” drive tugs are more universal, and are popular throughout the many pilotage districts in the world, but particularly in Japan, and Far East.

Tugs Total Bollard Pull and Wind Force:

In order to carry out the manoeuvres safely and successfully the Mooring Master, as well ship’s Captain should have the clear idea regarding wind force acting upon the ship, and compares it to the total bollard pull being available from the local tugs.

Ship’s movement and balancing the tugs:

Ship’s movement is radically changing the efficiency of the tugs. As it was discussed before when the vessel is making headway her pivot point is moved forward, and on the contrary ship begins to make sternway has the pivot point transferred aft.

In both cases the levers, and moments are changed.

Depends on the planned ship’s movement the tugs must be positioned accordingly.

In figure 49 A and 49 B is given step by step the example of using the anchors and tugs when berthing to the CBM.

On approaching the berth a ship’s line is passed to one tugboat from the centre fairlead aft. This hawser should be of good strength and made well fast on tanker’s board. When in position off the berth, the starboard anchor is dropped and slacked away easily to about 9 or 10 shackles on deck. The port anchor is then let go and paid out freely as the tanker turns into the berth using the tugs and main engine as required. At the same time, the starboard anchor is hove in to about 6 or 7 shackles on deck and then ready to slack away again.

The first tug has good towing position, but to be reasonable effective should be positioned as far aft as possible.

The second tug is used to assist in the lateral positioning of the tanker.

Both tugs are also used to keep the tanker away from the manifold marker and the mooring buoys

In the step marked “2” the ship is making sternway, and her pivot point is shifted towards the stern.

In this case the second tug is working at an excellent lever when swinging tanker’s bow to starboard.

Step “3”:

As the tanker backs down the berth the anchors are slacked away as necessary, and the lines are sent to the forward (No. 4) buoy. Now the second tug is shifted towards the ship’s port quarter in order to assist in the lateral positioning of the tanker’s stern. When the stern passes close to the starboard quarter (No. 1) buoy three stern lines are sent away to this buoy by the mooring boat.

Step “4”:

The VLCC is almost stopped, and the anchors arrest her bow. Due to position of the pivot point shifted now more forward, the second tug is working at good turning lever.

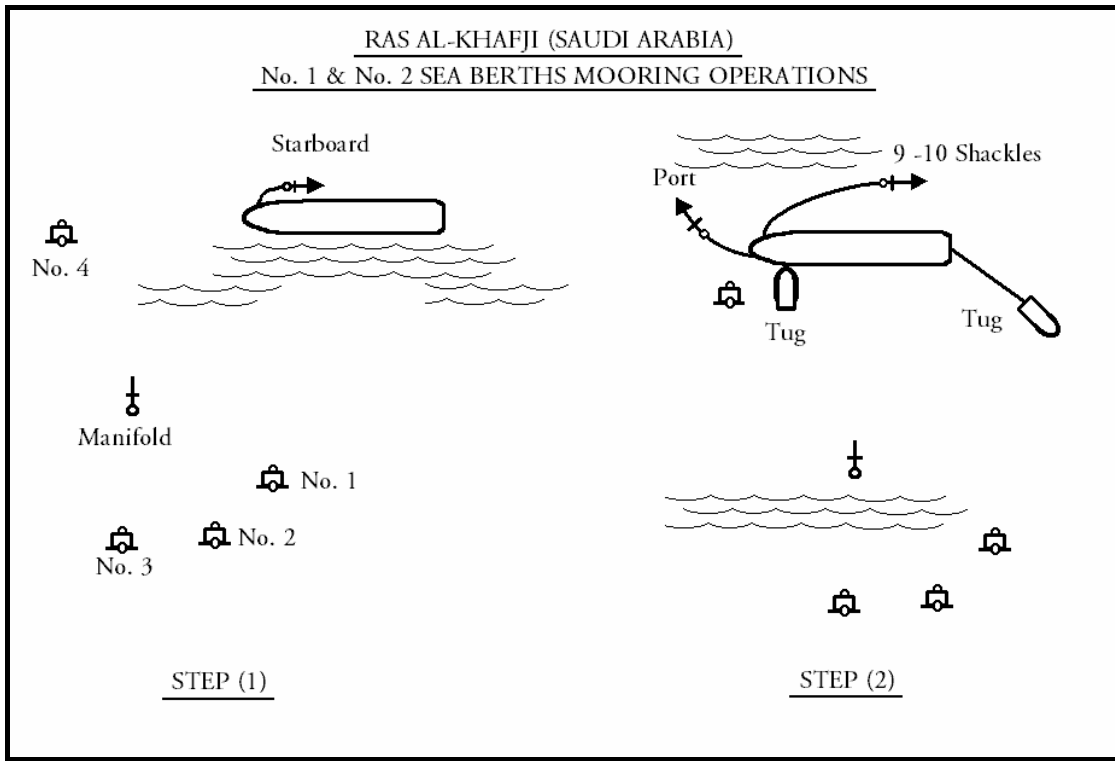

Fig. 49A. Berthing to CBM using the anchors and tugs.

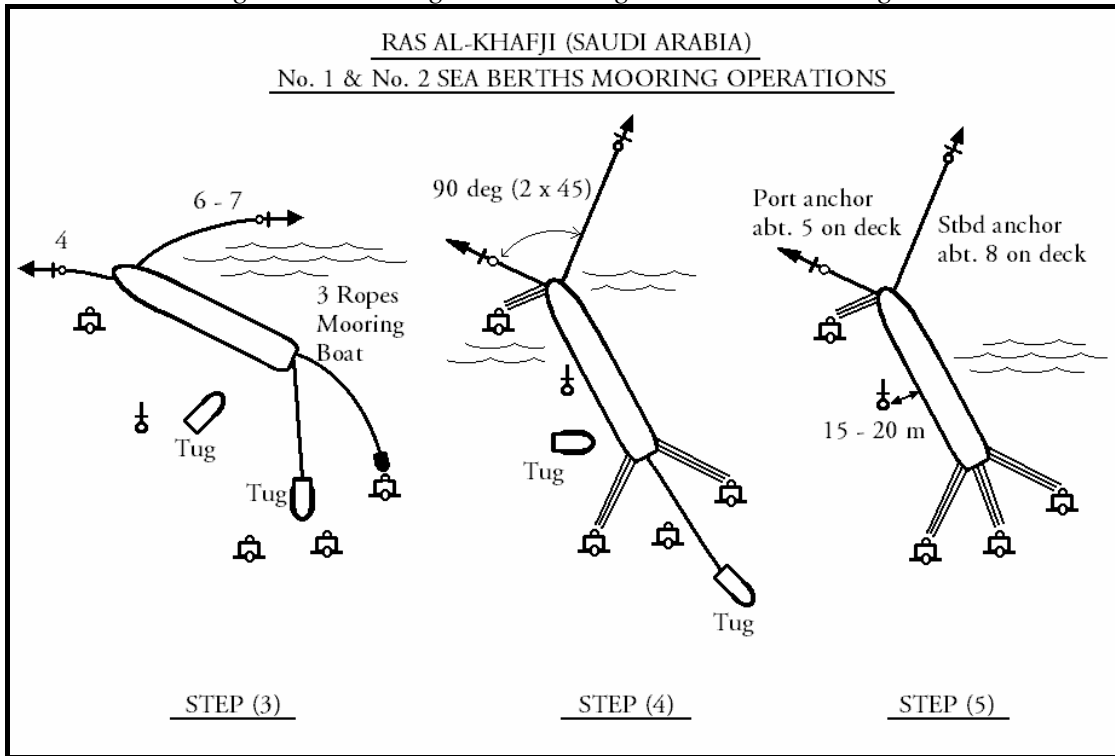

Fig. 49B. Berthing to CBM using the anchors and tugs.

Leaving the CBM - the typical sequences

General idea

When loading is completed, hoses are disconnected and lowered to the seabed, under the supervision of the Mooring Master.

The conventional procedures for leaving the berth are included in the following steps:

- The tug, or tugs (if any) are on station.
- Lines to buoys are slackened back by the vessel's crew then released at the buoy by the mooring launch crew. The sequence of letting go the mooring lines depends on the prevailing weather conditions.
- Anchors are either heaved in simultaneously, or one by one. See remarks below.
- The tugs, if available are used to keep the tanker away from the manifold marker and the mooring buoys.
- The Mooring Master leaves the vessel after it is underway and clears of the moorings.

The Sequence of casting off the mooring lines

The sequence of letting go the mooring lines depends on the direction and force of wind blowing during unberthing from the CBM.

Leaving the CBM with strong wind on the bow with the spar and hose buoys on the lee side is shown in figure 50.

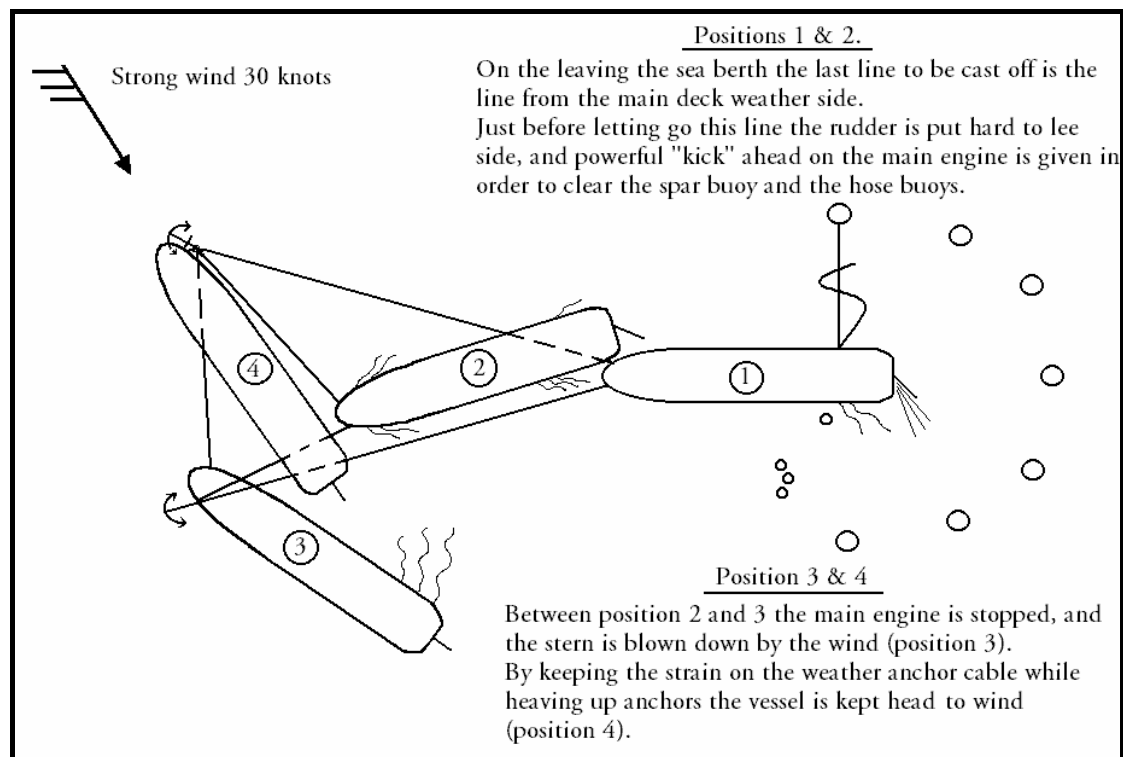

Fig. 50. Leaving the CBM with strong wind on the bow with the spar and hose buoys on the lee side.

In order to clear these buoys the last mooring line to be cast off is the line from the main deck weather side. Just before letting go this line the rudder is put hard over to

the lee side (in our example - hard to port), and powerful “kick” ahead on the main engine is ordered.

Most probably the VLCC is in loaded condition, and deep in the water, therefore inertia and momentum start playing an important role.

In such case it takes time to overcome the rotational momentum by the wind force, and meantime heaving on the lee anchor (port side in fig. 50) should bring the vessel forward clear off the buoys.

Even working ahead on the main engine temporary will shift the pivot point ahead. With slight headway the vessel’s stern is falling down the wind. Keeping the strain on the weather chain while heaving up on the lee anchor will bring the vessel up to wind.

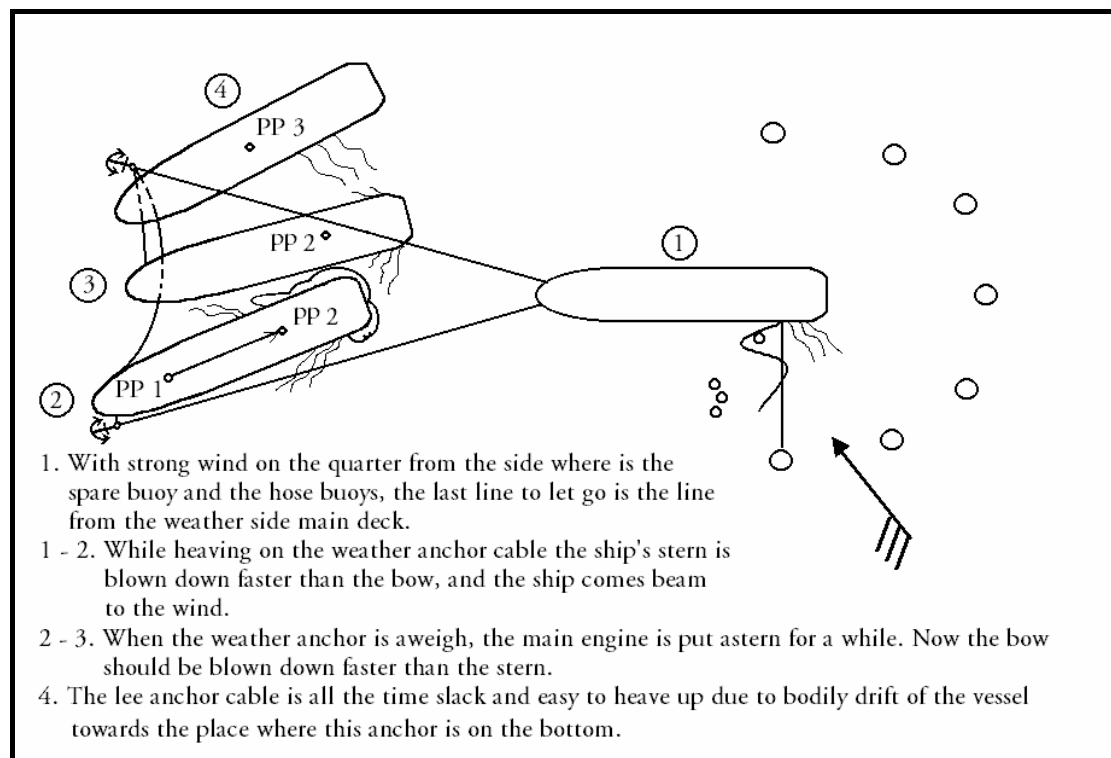

Fig. 51. Leaving the CBM with strong wind on the quarter with the spar and hose buoys on the weather side.

With strong wind on the ship’s quarter from the side where is the spare buoy and the hose buoys the last mooring line to be cast off is the line from the weather side on main deck (see figure 51).

While commenced heaving up on the weather anchor cable the vessel gets the force exerted by the windlass. She starts moving ahead following the lead of the anchor cable. The pivot point will shift forward, and stern is blown down the wind faster than the bow. The ship comes beam to the wind (fig. 51, positions 1 – 2).

When the weather anchor is aweigh, the main engine is ordered astern for a while.

Sternway will move the pivot point again aft, and now the bow should be blown down faster than the stern (fig. 51, positions 2 – 3).

Due to bodily drift of the VLCC towards the place where lee anchor is on the bottom the cable is all time slack and easy to heave up (fig. 51, position 4).

Heaving up on the anchors

With light wind when all mooring lines are cast off, the vessel starts movement ahead caused by strain on the anchor cables.

The direction the cable is leading is not always straight towards the anchor due to fact that large vessels have very heavy anchor chains and this is not possible to pull the cables into perfectly straight lines when backing the vessel to its final berthing position.

During heaving up the anchors the vessel will follow the leading of the chains, and therefore the main engine and rudder assisting in heaving up anchor must be used temporarily and reasonable

When the chain comes tight heaving up should be ceased in order do not damage the windlass.

If it was decided to heave up the anchors one by one, the strain develops on the second anchor chain when there are about 4 shackles remain on the first.

At this moment both anchor chains become tight.

To protect the windlass against a breakdown, especially aboard older vessels the proper slack must be given on the second (not hove in) anchor chain.

At least should be slacked away same amount of cable as it was original distance between both anchors.

If both anchors are heaving up simultaneously situation is similar, as described above.

Under normal circumstance slack is given on the weather anchor chain, then lee anchor is hove in, and when is aweigh, heaving up of the weather anchor is resumed.

DREDGING ANCHORS

General Remarks

Phraseology:

There is difference between dredging and dragging. In both cases anchor is not holding ground, and flukes are not dig deeply into the sea-bottom.

Anchor is dragging when the holding power of the anchor plus the weight of chain is not enough to keep the vessel in position. It could be caused by force of wind, tide, engine or combination of forces. Simply this is an unfortunate event, does not depends on the ship handler will. When dragging the ship has sternway, or is moving sideways.

Dredging of the anchor is planned and carried out by keeping a minimal speed over the ground with constant strain on the chain. The vessel can dredge the anchor with headway or down, with sternway.

Weather, lee, or both anchors can be used when dredging with headway.

General:

Dredging of anchor can be used either as part of berthing plan or in case of emergencies, as emergency measure

Dredged anchor steadies the ship's heading, slows her speed, and the bow may be brought very close to and without risk of collision with berth.

Successful use of anchor when berthing depends on such factors as local knowledge, adequate under keel clearance, size of the vessel, limitation of ship's windlass and anchor equipment, skills of ship handler and ship's crew, etc.

Under the term local knowledge is understood type of sea bottom (which should be free of such obstructions as underwater cables, pipes and rocks), range of tides, local port restrictions and regulations.

The officer forward must be sure the man on the windlass does not apply the brake too early, or too late when dropping the anchor either in case of emergency, or as part of planned manoeuvre. As it was pointed out under the section "Basic Anchoring Methods" with one and half up to 2 shackles maximum in the water the brake must be made fast. If approaching speed is very slow (large vessels) too many shackles paid out will pile up cable on top and foul the anchor. With high speed and brake applied too late, or too fast the brake linings may be burn out or the chain be parted. From other hand if the brake is applied too soon it will be not enough amount of cable in the water and the anchor will not reduce the vessel's speed.

Regarding the limitation of the windlass especially of large vessels see remarks written earlier (Basic Anchoring Methods Step By Step).

Dredging weather anchor with headway

The most difficult to handle in confined, tidal and windy waters of the Northern Europe is a ship of about 90 up to 110 metres length overall without special rudder and bow thruster installed.

Dredging weather anchor with headway becomes the common practice when berthing such older type of coaster, and therefore three basic ship-handling rules known since time immemorial are as follows:

1. Keep up wind.
2. Keep up tide.
3. Anchor is your best friend.

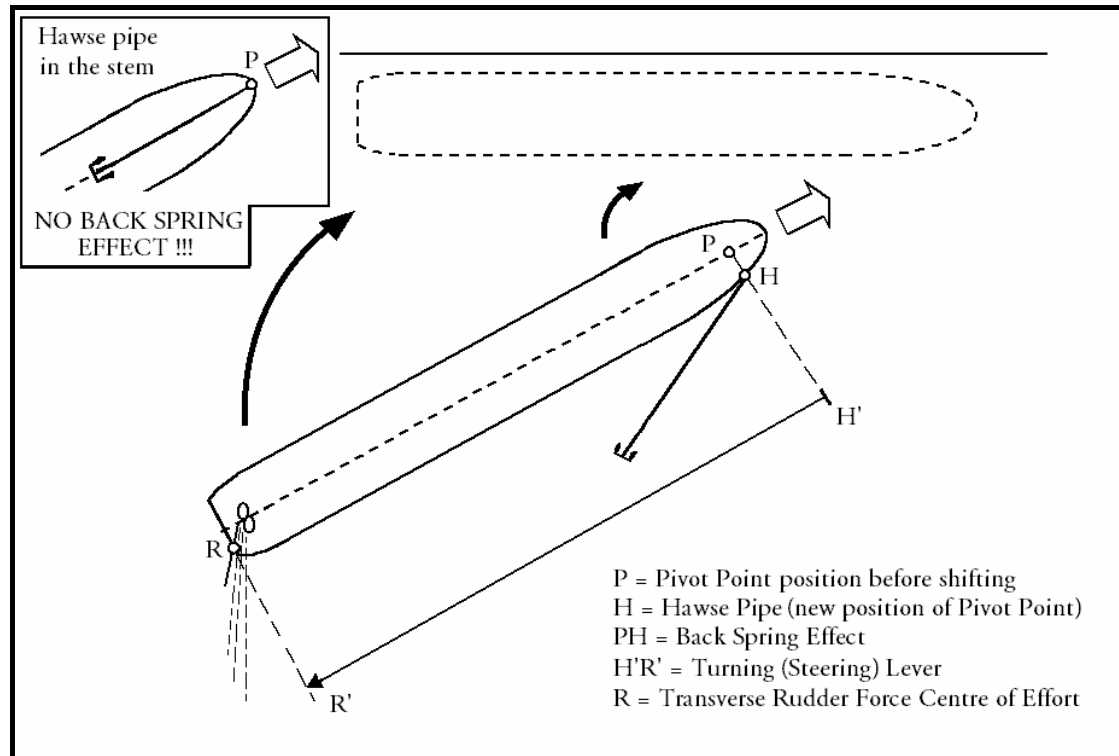

Fig. 52. Dredging weather anchor with headway.
“Back Spring Effect” and Turning Lever.

Successful dredging depends mainly on keeping the minimal speed over the ground and a constant strain on the anchor cable.

Assume the vessel has only one hawse pipe situated exactly in the stem.

When dredging this anchor the pivot point is situated just forward in the stem, but when one of two bower anchors is used, particularly on large beamed vessel, with hawse pipes more aft, the pivot point is moved from the fore and aft line to the lower part of the hawse pipe (towards the ship's side).

This is creating the turning moment acting on the lever PH (see fig. 52).

Because this moment is working in same manner as a back spring, its effect is called “Back Spring Effect”.

This effect is felt since the moment of dropping the anchor particularly when ship is small and in light condition. The helmsman must be instructed accordingly by the pilot or Master, and counter the turning tendency by the helm in order does not turn the vessel too early and keep straight line of approach in the first phase of the manoeuvre.

The anchor should be walked out or dropped as early as possible in order to give sufficient time to adjust the length of the anchor chain and main engine revolutions. This is prudent ship handling manner, which gives proper feeling of the ship's behaviour enough early before the berth is reached.

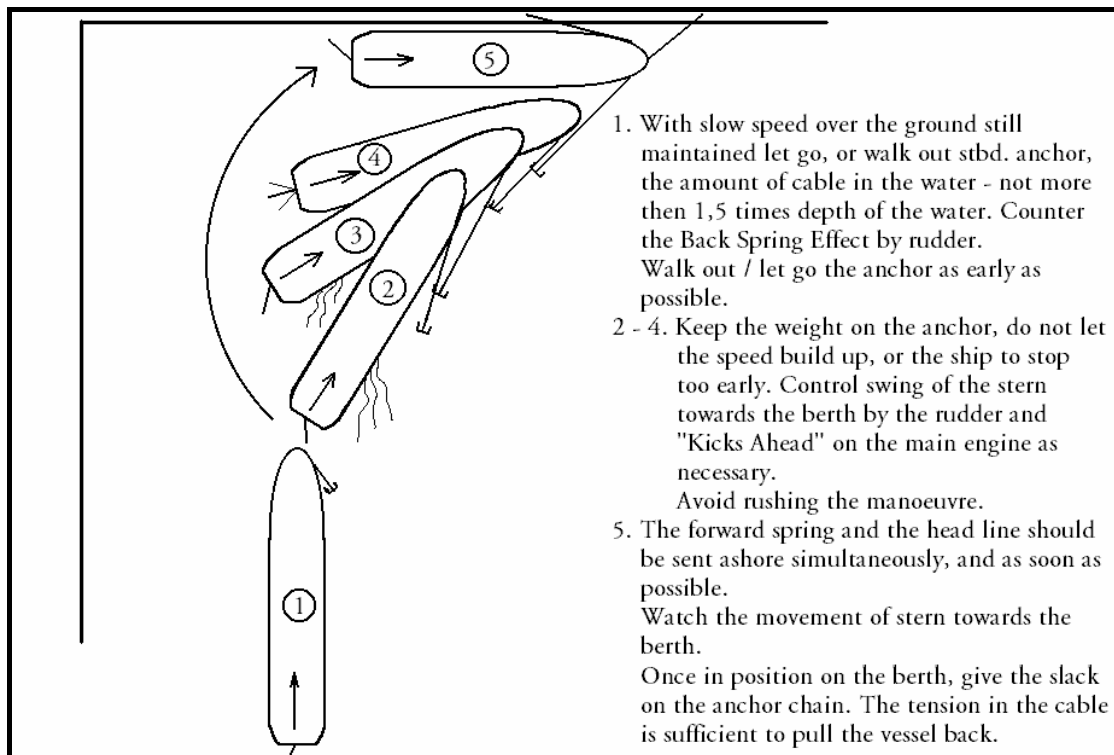

Fig. 53. Dredging weather anchor with headway.

As customary on smaller vessels the anchor is dropped for dredging, but on the larger ships, especially with multinational crew and unknown anchor equipment seems better to walk out the anchor in the gear, then let it go directly.

As it was stressed before the weight on the anchor must be kept continuously, but without the speed building up, or stopping the ship too early. The movement of the stern towards the berth must be controlled carefully, particularly with strong onshore wind and close to the berth. If wind is strong and blowing onto the quay the angle of approach should be larger, and the forward spring and headline sent ashore simultaneously as soon as possible. In order do not hit the berth by the ship's stern in the last phase of this manoeuvre, the rudder is put hard over towards the quay and enough strong "kick" ahead applied.

Main turning moment needed to swing the vessel almost in place, or keep easy the desired heading is achieved because of long lever arisen between new position of pivot point "H" and Centre of Effort of Transverse Rudder Force "R" (see fig. 52). This lever is also known as The Steering Lever.

The additional to the main turning moment is mentioned earlier "Back Spring Effect." Both of them are very useful in the case a large swing in confined waters is necessary prior to berthing, or strong wind is blowing from the berth direction.

Once with ship in position alongside the berth, and forward - aft springs and lines made fast (single up), the slack on the chain must be given. It should be kept in mind the tension in the cable is quite sufficient to pull the vessel back.

Depends on the situation the anchor is left at the bottom, with the slack given on the cable (up and down), or heaved in.

If decision is to heave up the anchor it is often necessary to take the bow little a bit off the berth, and therefore the stern must be well secured by the appropriate fenders.

Dredging lee anchor with headway

Dredging lee anchor is not popular and rare used method, but seems very useful in case of emergency, or if ship in light condition is drifting fast towards the lee berth. Lee anchor holds ground faster, because the cable leads more horizontal. The anchor keeps vessel bodily against the wind.

The friction between the cable and ship's side eases the strain on the windlass. With the main engine working ahead and lee rudder applied better leverage is achieved.

But there are some limitations and possible disadvantages in use of lee anchor. They are connected with required minimal ship under keel clearance, which should be at least 20% of the maximum loaded draft of this vessel.

Almost always fully loaded vessel is approaching the berth with minimal under keel clearance, what automatically cancelling use of lee anchor.

Even if vessel has arrived berth in ballast condition the anchor must be heaved in before commencement of loading, because most probably the draft is limited on sailing. This needs to take the vessel off the berth due to possible difficulties in heaving up anchor (additional strain caused by friction between the anchor chain and ship's hull).

Anyway better loose the time planned for loading, and pay overtimes to stevedores, than have the heavy contact with the berth.

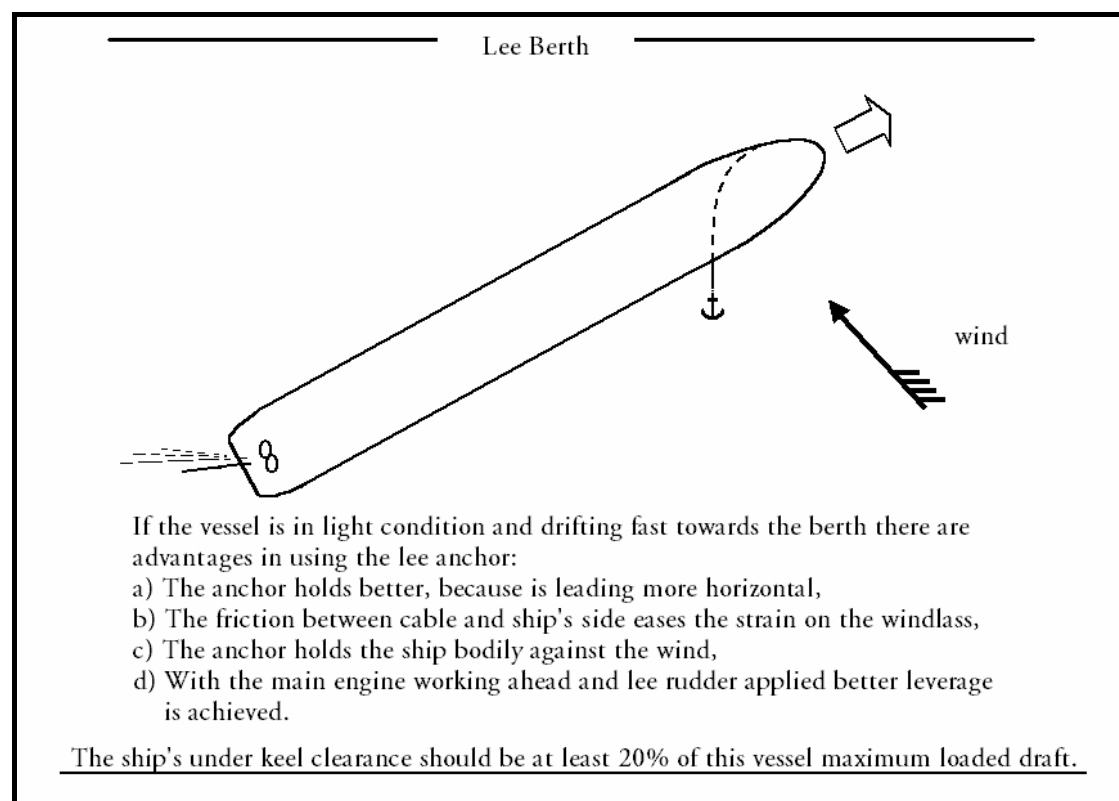

Fig. 54. Dredging lee anchor with headway.

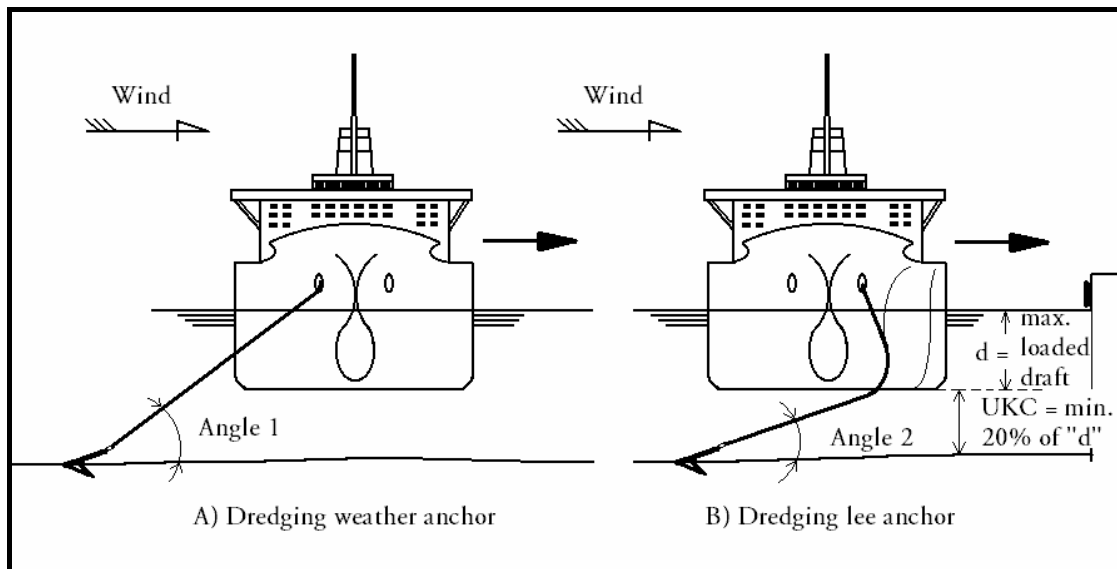

Fig. 55. Comparison of dredging weather and lee anchor.

Dredging two anchors with headway

From the theoretical point of view when approaching the berth directly, without any planned turn dredging two anchors is much better than dredging one, because achieved effect is doubled.

With two dredged anchors the “back spring effect“ (see fig.56) is cancelled and positioning the ship’s bow is much more easier. The ship’s bow is driven on the anchors to the planned position, and remains there.

On powerful diesel main engine of high revolutions on dead slow ahead, and classic fixed propeller less “kicks” ahead, and therefore starts are needed in order to keep required small headway.

Dropping of two anchors needs to keep always safety under keel clearance in order does not damage the ship’s bottom.

Both dredged anchors do not foul each other while the vessel is turning because one anchor cannot reach the cable of the other (if the small ratio of anchors chains length to the depth was chosen, as it is advised).

However dredging two anchors with headway is not advised if a large swing in confined waters is necessary prior to berthing.

On large beamed vessels one more skilful man is needed forward to operate the second windlass. This is not always easy with present worldwide tendency to employ smaller crew.

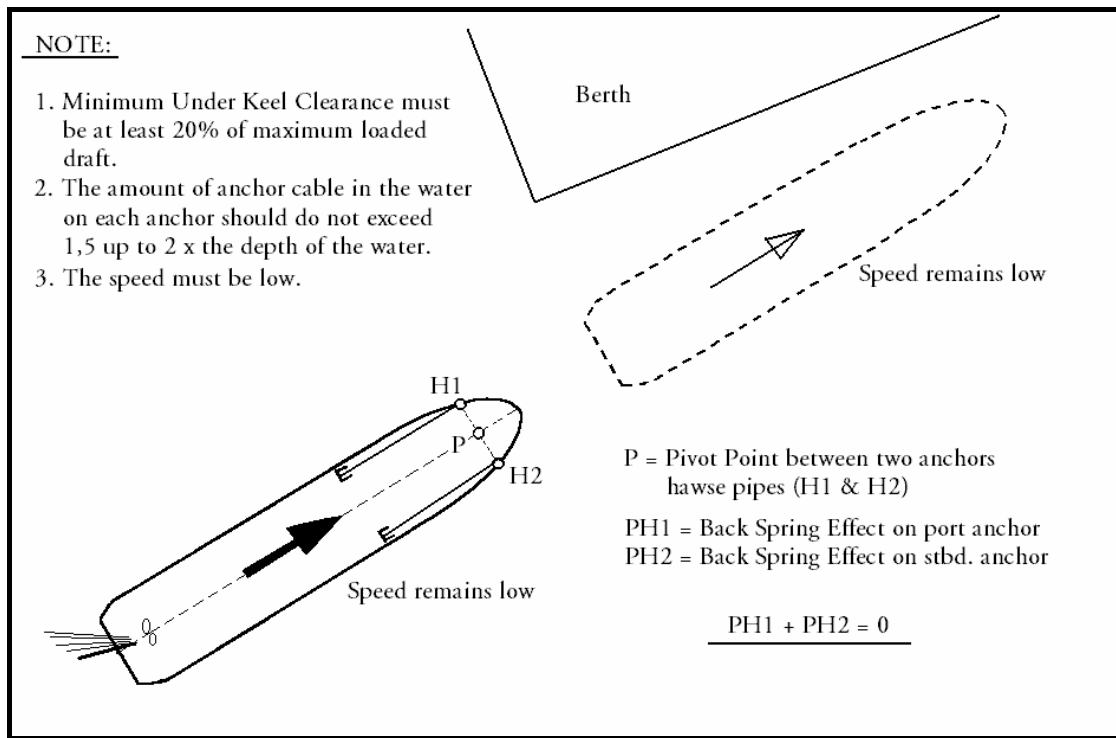

Fig. 56. Dredging two anchors with headway.

In emergency when vessel approaches berth too fast or going aground (because of “blackout”, main engine, steering gear problems etc.) both anchors are usually dropped almost simultaneously in order to slow down the speed as soon as possible. This is old not written, but time-honoured custom never go aground with anchors in the hawse pipe.

Dredging with sternway

Dredging the anchor with sternway is rather rare used method. With short amount of anchor cable in the water, just to keep the ship’s head against the wind or current, but not stop the dragging, a vessel’s movement can be controlled to a certain extent by use of anchor and rudder.

Assume at anchorage there is no current and the wind is acting only (Fig. 57).

For some reason vessel has to change her position to new one situated down the wind.

At first the anchor cable is shortened to the point at which the anchor starts to drag.

Dredged anchor keeps the ship’s head against the wind but vessel is moving astern.

With ship’s sternway the flow of the water is acting at the rudder from the opposite direction than with headway, and therefore vessel’s stern is following the rudder position e.g. if ruder is put to starboard the stern is swinging to starboard too.

We may expect the ship will move diagonally across the wind towards the direction, which the rudder is turned.

Due to fact the hawse pipe is not situated in the fore and aft line (at centre of the bow), the vessel’s natural position when dredging the anchor becomes canted just opposite to the anchor.

This phenomenon was used by the author to steer (to some extent) disabled vessel “John N”, and pass safely between anchored vessels at the Keelung Roads in January 1990. Alternately both anchors have been walked back and heaved up in order to move away the ship’s stern from the nearest anchored vessel.

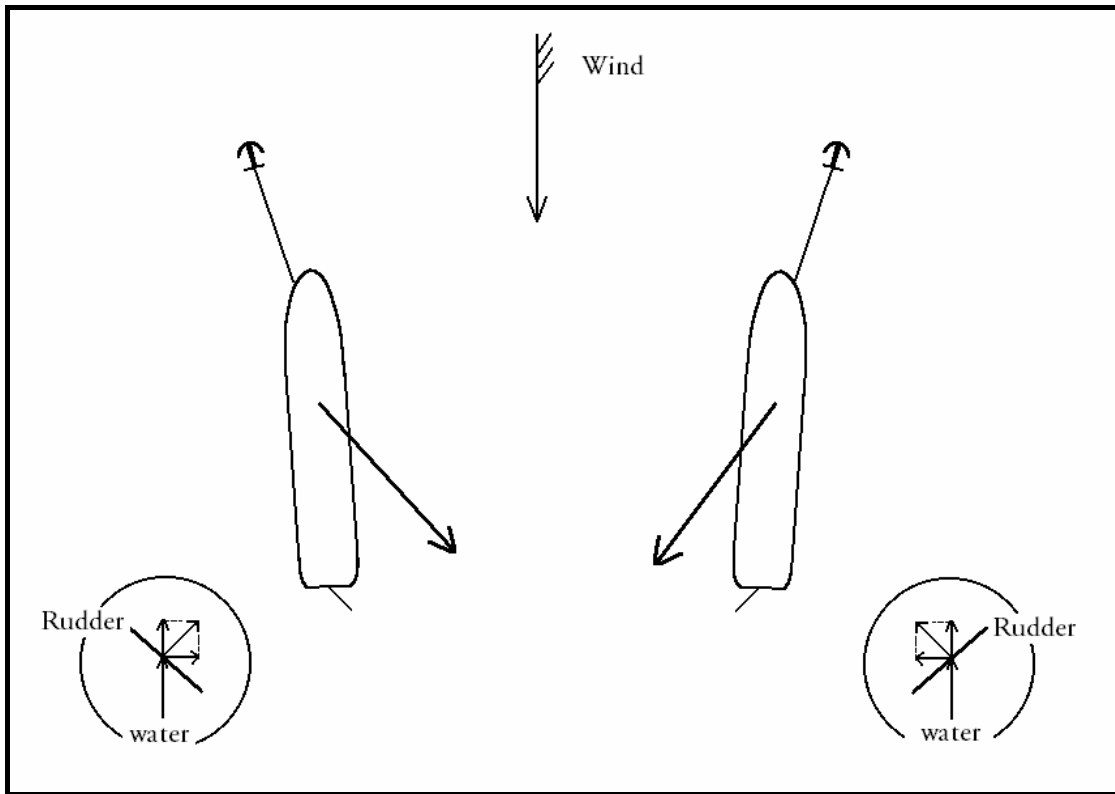

Fig. 57. Dredging with sternway – wind acting only.

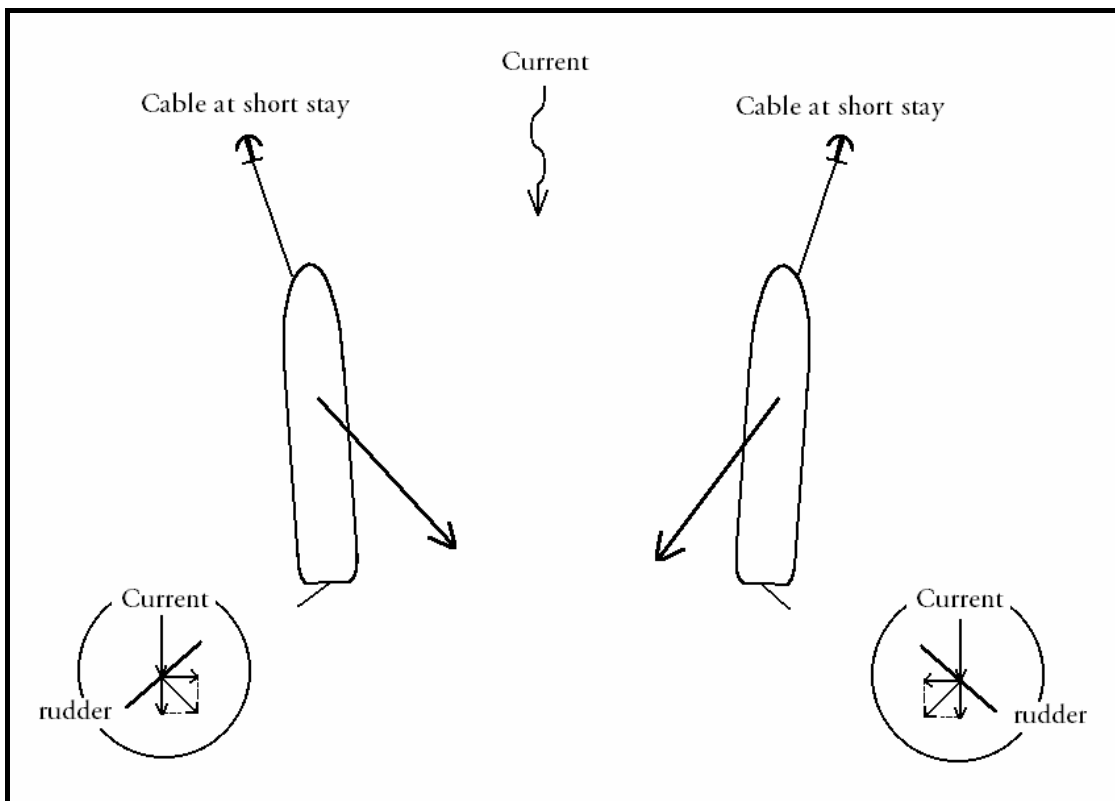

Fig. 58. Dredging with sternway – current acting only.

In case dredging down the anchor with the current (Fig. 58) the vessel has headway with reference to the water, because the ship is moving slower than the water flow. If difference between rate of the current and the ship's sternway is enough large the rudder can be used to steer the vessel. If necessary short bursts ahead on the main engine will give the vessel a sheer.

Generally the ship steering is exactly same, as with movement ahead. If the rudder is put to starboard the stern is going to port and vice versa.

The technique of dredging the anchor with sternway can be used also to great advantage when berthing without the assistance of tugs in strong current.

Swinging on an Anchor

In narrow, restricted waters an anchor can be used to carry out a tight turn through about 180 degrees (Fig. 59).

The success of this manoeuvre depends on such factors as are mentioned below:

1. The sea, river or canal bed (must be clear of obstructions).
2. Type of the bottom (allowing use of the anchor – the local knowledge once again is vital).
3. The depth of the water (should be suitable).
4. Appropriate underwater clearance (as we remember required minimal ship under keel clearance should be at least 20% of the maximum loaded draft of this vessel).
5. Size of the vessel.
6. Type of engine power available.
7. Transverse propeller turn when going astern.
8. Amount of room available for swinging.
9. Strength of wind and /or current.
10. Ship's speed over the ground in the moment of letting go the anchor.
11. Experience and skill of the ship handler.

If that is practicable the swing should be planned in a direction that transverse propeller thrust when going astern would assist the turn. For example with fixed right hand propeller better is turn the vessel to starboard, because when going astern the propeller transverse thrust is pushing the stern to port, and therefore assists the swing. When approaching the turning place the speed should be minimum, just for steerageway only, but still ahead in order to keep the pivot point well forward. The sternway should be avoided due to shifting of pivot point aft, and therefore reduced the turning lever.

Shortly before dropping the anchor ship should be canted into the proper side in order to keep the current or wind on the correct quarter and assist the swing.

The ship handler must be ensured that there is enough space and deep water for the stern to turn around.

To ease the weight on the windlass the main engine should be put astern before the brake is applied.

In a narrow river the main stream is much stronger in the centre of the channel than at the sides, therefore before carry out the turn the bow should be manoeuvred into the relatively slack water closer the river bank. The stern remains in the stronger flow will be pushed downstream.

With anchor dropped and on the brake, even not holding ground the pivot point is transferred forward. Now the wind, tide flow or river current are working on a good

turning lever and the vessel starts swing around. To accelerate the rate of turn the main engine can be used with the rudder hard over and powerful bursts ahead applied. It should be stressed that the windlass must be protected against taking the full weight of the vessel on the strong tide, and it is almost always necessary to come ahead on the main engine with assistance of the appropriately positioned the rudder to ease the weight on the windlass.

Once up the wind or tide the vessel is easier to control. That time the windlass is put in the gear, anchor heaved up and the ship can proceed, as it is required.

The amount of anchor cable used to carry out described manoeuvre depends mostly on depth, type of bottom, size of the vessel and weather condition (wind, current). Under the normal circumstances with one and half up to two shackles maximum in the water the brake must be made fast.

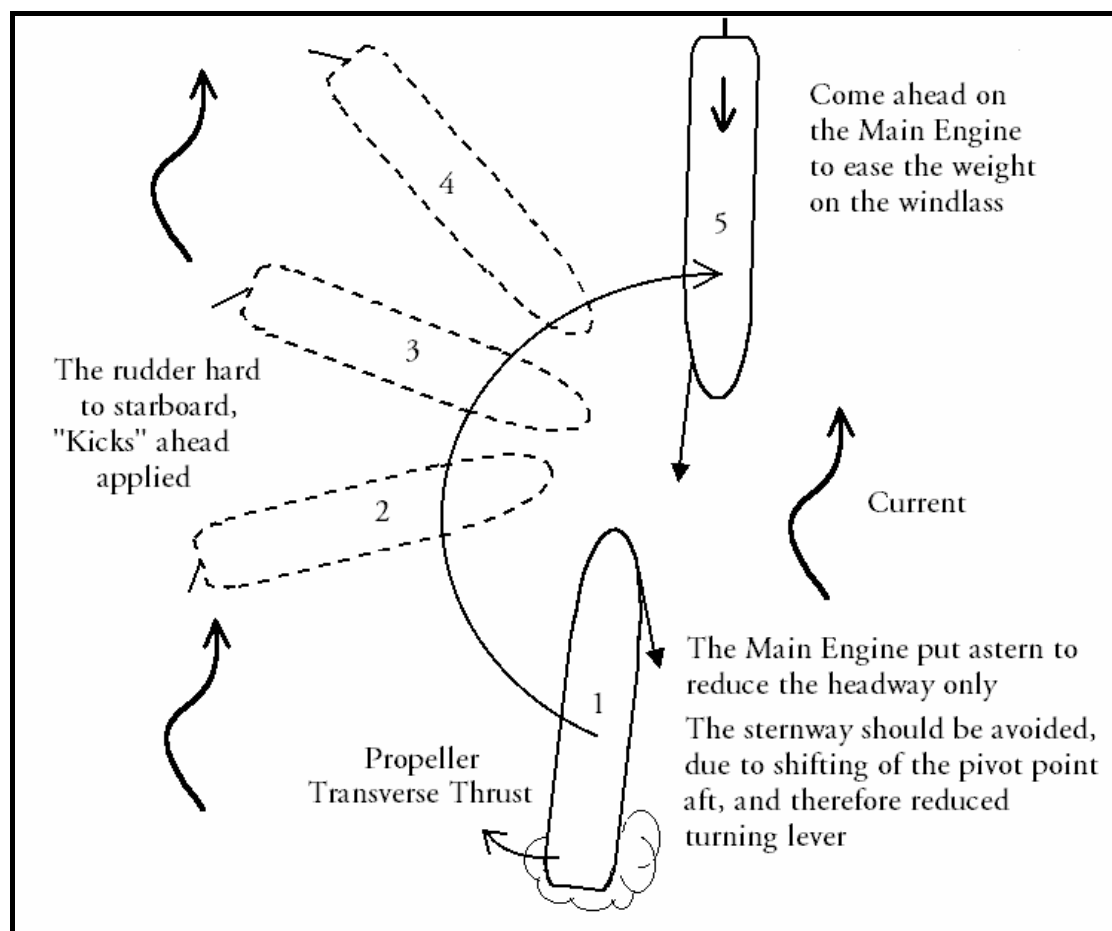

Fig. 59. Swinging to a Tide on One Anchor.

ANCHOR TO ASSIST BERTHING ALONGSIDE

Properly used anchor is very useful ship handler's tool when berthing, or unberthing without tugs.

Even when the tugs are available at some berths it is desirable to drop the anchor as the supplementary mooring in order to prevent damage to the vessel and berth caused by movement of the ship while lying alongside. Anchor dropped in the approach to the berth is often used to heave the ship's bow off on departure.

One of the districts where almost all, "Panamax" size, and even larger vessels are berthing without tugs is the Parana River, Argentina.

In figure 60 are shown "step-by-step" the approach and berthing to the grain silos (Berth No. 6) at San Lorenzo in Parana River.

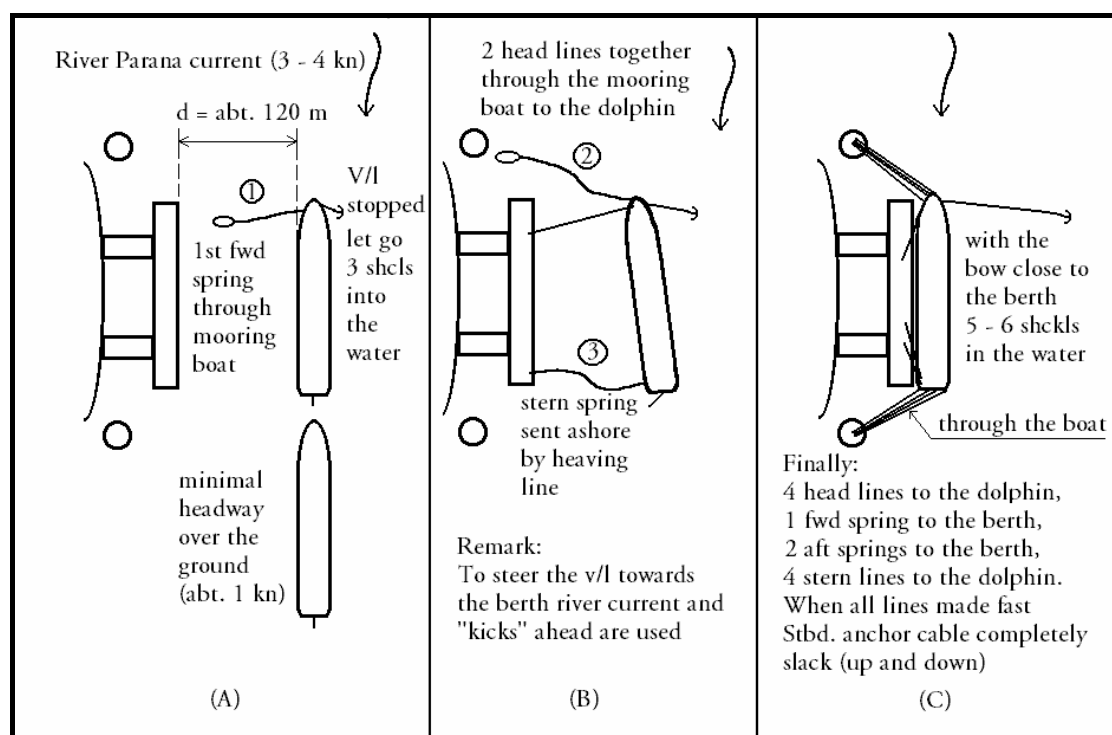

Fig. 60. Berthing to the Silos, Berth No. 6 at San Lorenzo, Parana River.

Position (A):

The vessel is steaming up the river against the current of about 3 – 4 knots. When the speed over the ground is of about 3.5 knots the main engine is stopped, but if is reduced to let say 1 knot (because of current), or the vessel doesn't answer the helm properly "kick ahead" technique is applied.

With the vessel almost stopped and positioned parallel to the berth in distance of about 120 metres the starboard anchor is dropped (3 shackles into the water).

Meantime the forward spring is sent ashore through the mooring boat.

Position (B):

The river current and “kicks” ahead are used to bring the vessel towards the berth. Even with the main engine stopped, but the rudder put to port the bow is coming close the berth. Two head lines together are sent to the mooring dolphin by the boat, forward spring is heaved in and the anchor cable paid out as necessary. As soon as possible the stern spring should be sent ashore by the heaving line.

With springs from the both ends, and minimum one headline on the winches the ship is pulled towards the berth.

The officer forward must watch carefully the anchor cable and position of the vessel. Too much strain on the chain will keep the bow off the berth and the stern may hit the wharf. Sometimes is necessary to put the anchor in the gear and pay out the cable.

From the other hand if the anchor cable is up and down there is no chance to stop the movement of the bow to port and the shore loading equipment is in the danger.

The ship must be kept almost parallel to the loading berth when heaving on the mooring lines.

Appropriate positioning of the rudder and “kicks” ahead is very useful to assist keeping the vessel as required.

Position (C):

Finally the vessel is made fast with port side alongside to the silos berth.

The bow is secured by four long headlines to the mooring dolphin, and one spring to the berth.

From the stern are sent also four, long stern lines to the dolphin situated behind the vessel. Due to strong river current two aft springs on the berth are required.

When all lines are made fast, the starboard anchor is put in the gear and the chain slacked up to 6-8 shackles in the water. With such amount of shackles in the water the cable is growing up and down.

STERN ANCHOR

The stern anchor, known also as a stream anchor is of about one third the required weight of the bower. This anchor is still required in some pilotage districts. For example in “Seaway Handbook” at page 7 is written: “Every ship of more than 110 m in overall length, the keel of which is laid after January 1, 1975, shall be equipped with a stern anchor”. As far as I know all coasters sailing to the ports in Rhine River must be equipped with the stern anchor.

In the past the stern anchor was found very useful for anchoring in a strong current from the aft in combination with the bow anchor in tidal narrow waters, as for instance in the Mississippi, or the Rangoon River.

If the tidal current is expected from either aft or fore direction all is working well, but the current acting on the ship’s beam has a disastrous effect.

In the last three decades use of the stern anchor aboard the merchant vessels has declined almost completely, and therefore there are not so many pilots and masters with experience in using the stern anchor.

The main danger in use of stern anchor is the risk of fouling the propeller and / or rudder by the anchor cable. To be on safe side the vessel should keep some headway on, when the stern anchor is dropped.

Even much more dangerous is heaving up the stern anchor. The vessel is coming astern while the anchor is heaved up, and the cable can easily foul the propeller and rudder. To avoid such situation this is recommended to keep the bow anchor just on the sea bed. This anchor does not allow gathering the sternway. When the stern anchor was used only, the bower anchor should be lowered on the bottom before commencing to heave up the stern anchor.

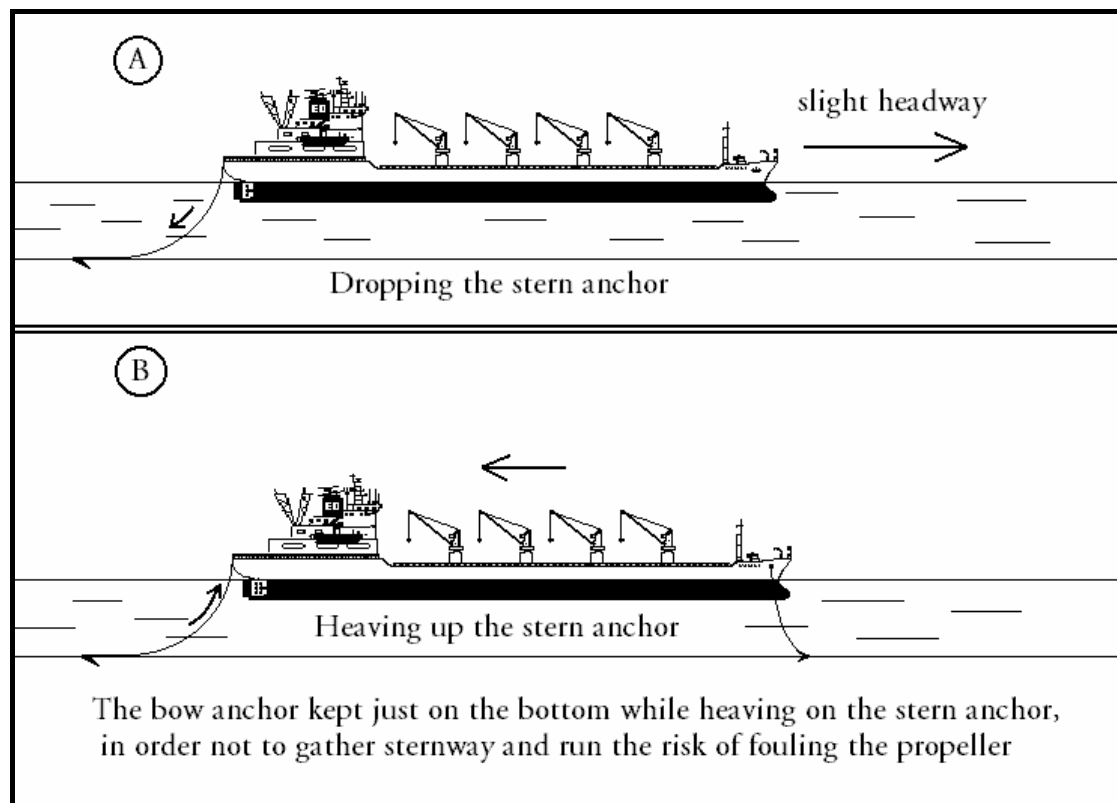

Fig. 61. The safe way of dropping and heaving up a stern anchor.

TIDAL FORCE AT ANCHOR

Deeply loaded large vessel anchored in tidal waters is restricting flow of the water. The problem becoming more critical with a ship at anchor on falling tide and under keel clearance progressively reduced.

Even weak current flowing under and around the hull of an anchored vessel is forced to accelerate its velocity. Because the water is few hundred times denser than air restriction of free flow is generating an enormous forces.

The ratio of the water depth to the vessel's draft is the most important factor in calculations of tidal forces acting on the ship's hull.

With a depth to ship's draft ratio of 1.05 the tidal force is three times stronger than with a depth to draft ratio of 3.0.

Other words we can say **the ship's under keel clearance** is the main factor in measuring of the tidal force acting upon the vessel anchored in the tidal waters.

This force is proportional to the square of the tide velocity.

The shape of the vessel's bow has a significant effect upon tidal force too.

As it is known well from the practice the modern bulbous bow of the fully loaded vessel is pushing the ship's forward part deeper into the water, therefore restriction in the tidal flow is increased to compare with sister vessel, but of traditional bow.

The knowledge of the factors having important role on the tidal force acting on the vessel anchored is an extremely important, because a strong falling tide and progressively reduced under keel clearance could exceed the holding power of the anchor and the vessel will drag.

In the figure 62 are shown longitudinal force acting on the bow of the "Panamax" size bulk carrier with 5 knots falling tide and the ratio of the water depth to the ship's draft varies between 3 and 1.1.

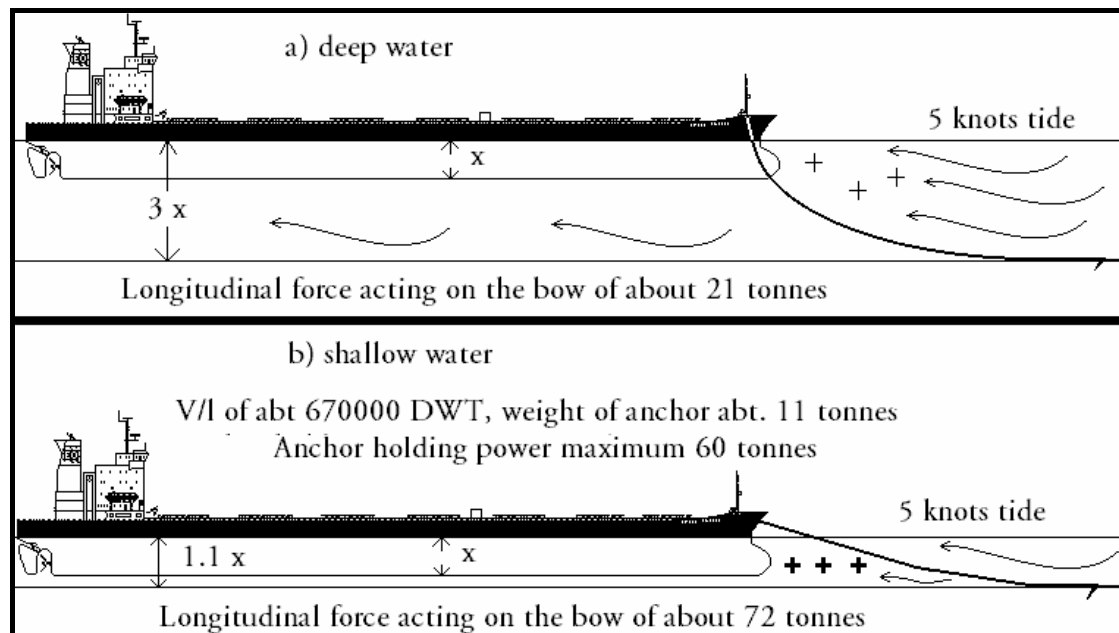

Fig. 62. Longitudinal tidal forces acting on the bow of the "Panamax" size vessel with 5 knots tide and different ratio of the water depth to the ship's draft.

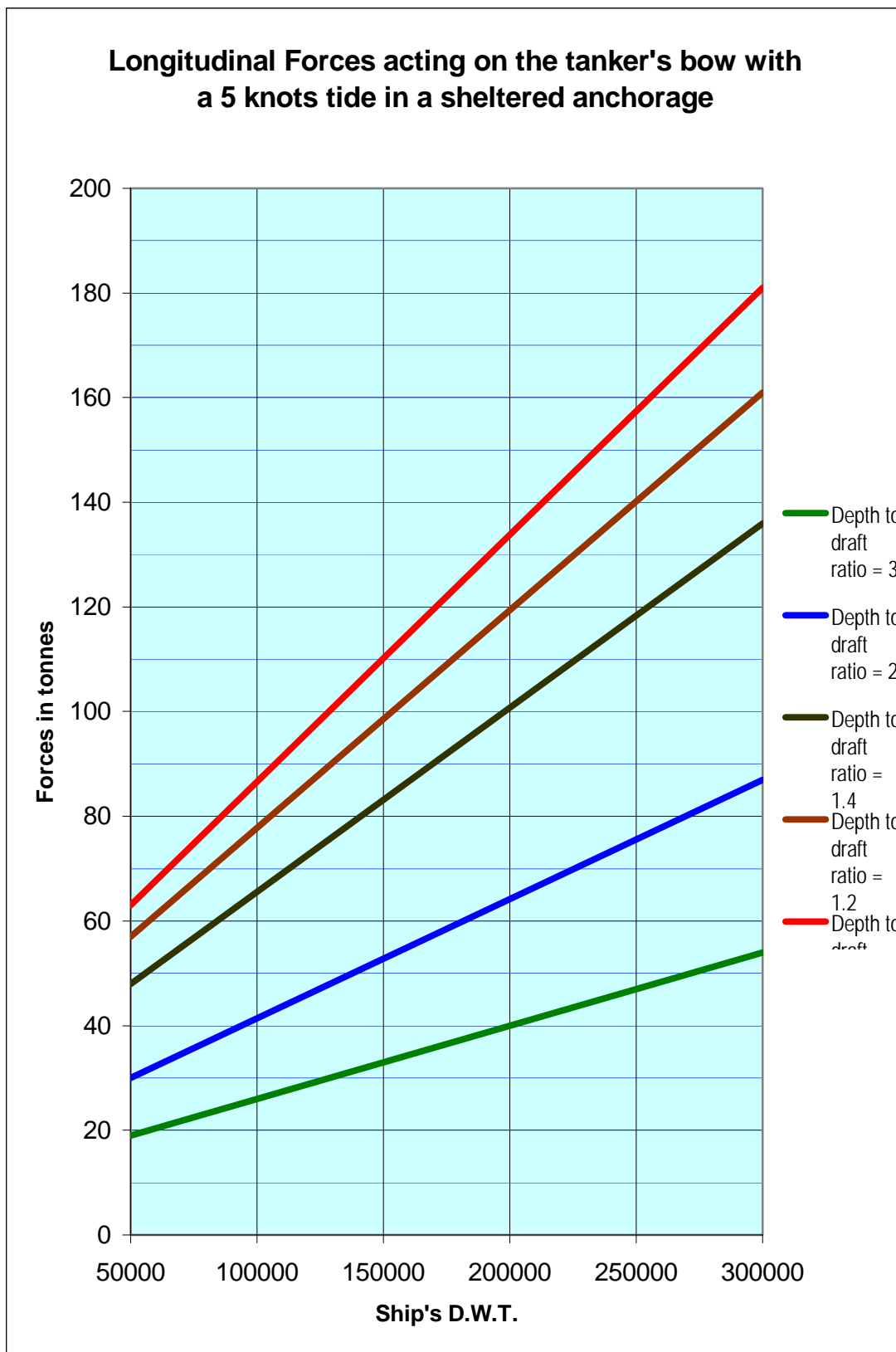

Fig. 63. Longitudinal tidal forces acting on the bow of different size vessels with a five knots tide and variable ratio of the water depth to the ship's draft.

Current Load on a beam of a stationary vessel (area of 100 sq. m.)

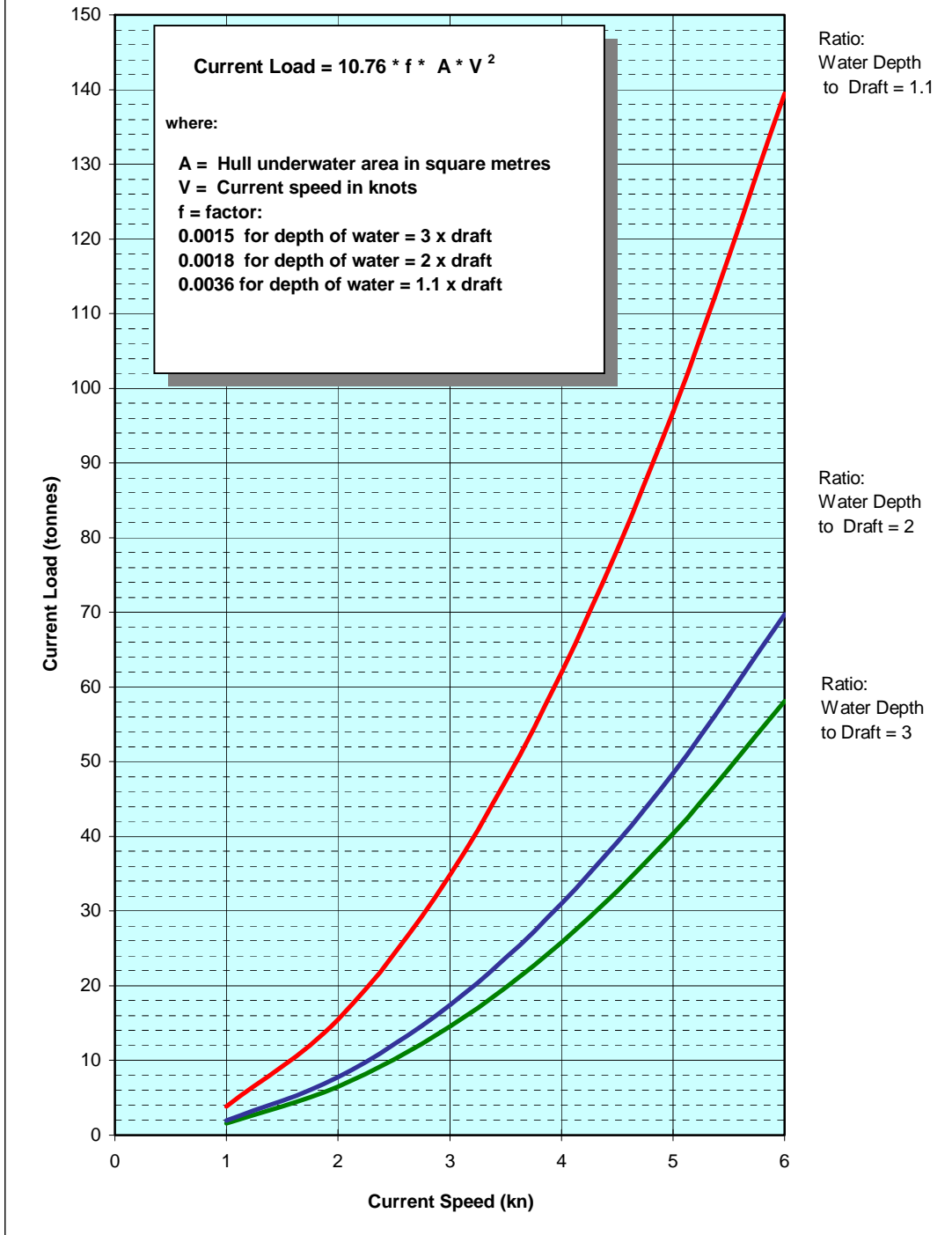

Fig. 64. Current load on a beam of stationary vessel (area o 100 sq. m).

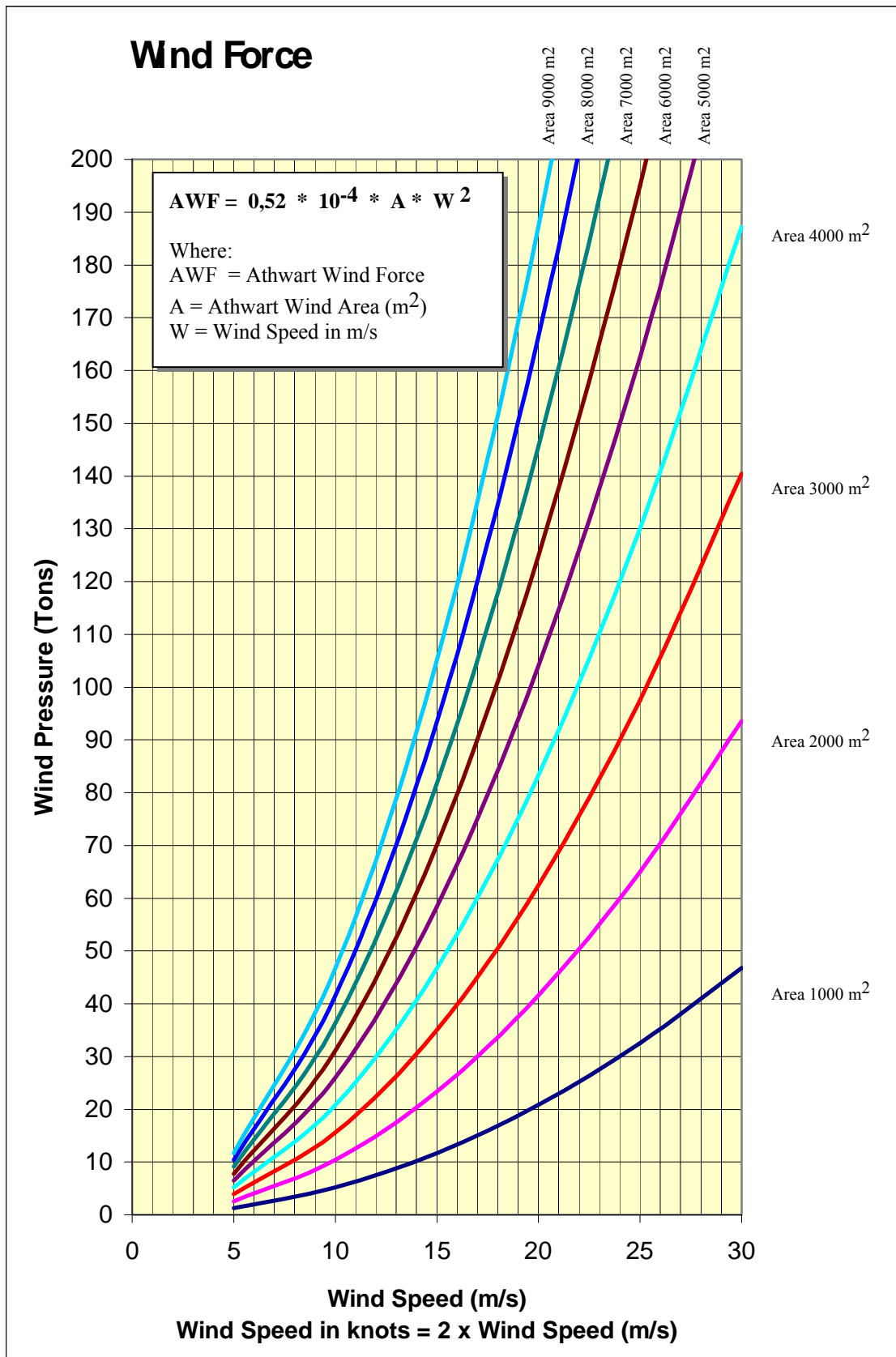

Fig. 65. Wind Force.

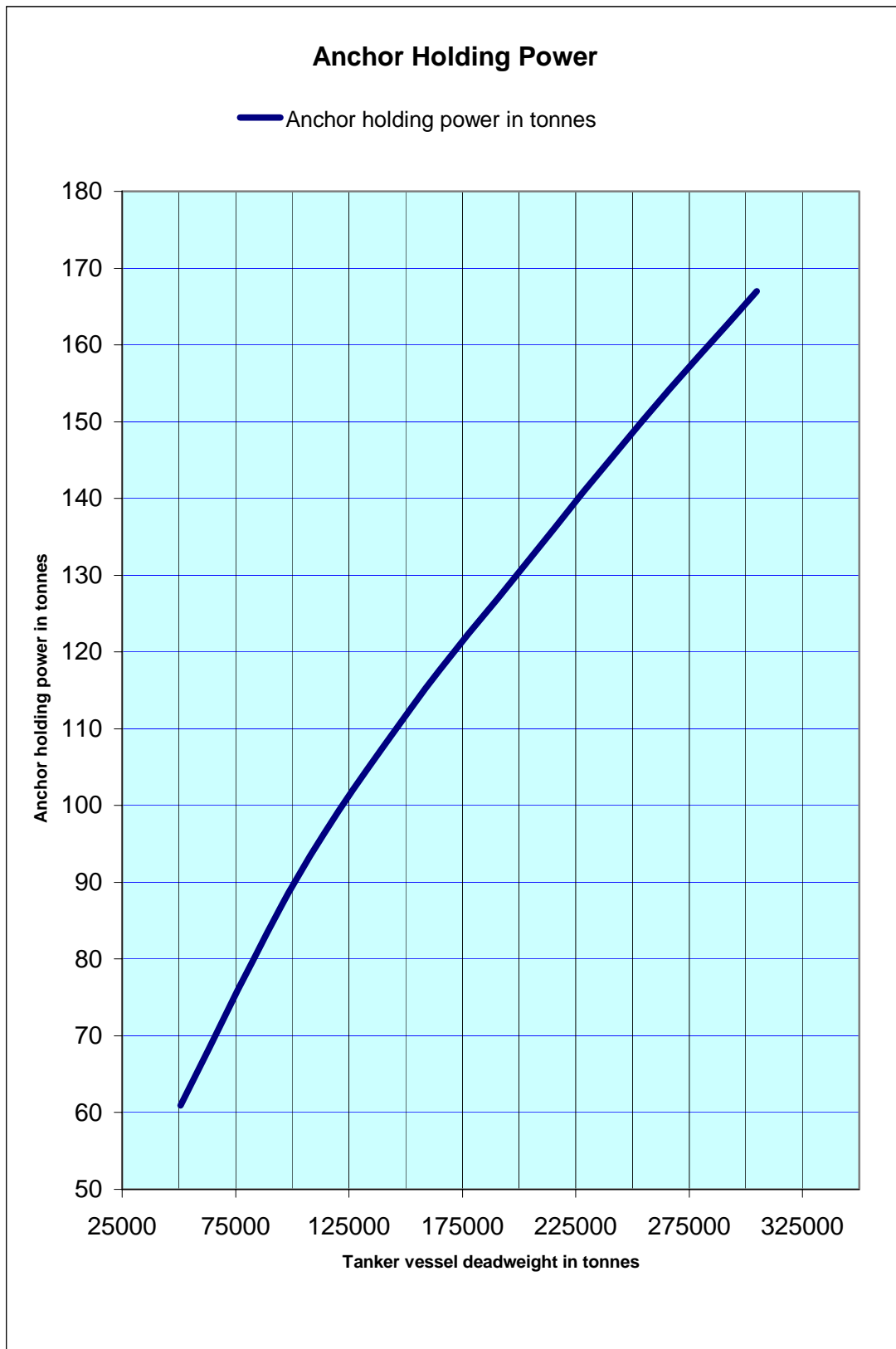

Fig. 66. Anchor holding power of different size tanker vessels.

ANCHORING AND ANCHOR WATCH CHECK LISTS

An anchoring plan should be prepared taking into account as follows:

- | | | |
|--------------------------|---------------|---------------------------------------------------------------------------------------------------------------------------------------------------------------------------------------------------------------------------------------------------------------------------------------------------------------------------|
| <input type="checkbox"/> | O.O.W | <p><u>1-Hour Notice.</u> Have the Master, Duty Engineer and the Chief Engineer been informed of the time of “Stand-by” for manoeuvring?
 <i>(Customary 1-hour notice is needed for change from IFO to MDO and from full sea to manoeuvring RPM <u>before the commencement of lessening the speed</u>).</i></p> |
| <input type="checkbox"/> | O.O.W | <p><u>Anchors and Windlass.</u> Has the Bosun unsecured and made both anchors ready to use (walked back)? Has the windlass been tested?</p> |
| <input type="checkbox"/> | O.O.W | <p><u>The Anchor Party / Helmsman / Flags / Hand held VHF.</u> Have the Anchor Party been informed of the time of “Stand-by” for anchoring? Is the helmsman on “Stand-by”? Have the necessary / required flags been hoisted? Have the hand-held VHF's been charged?</p> |
| <input type="checkbox"/> | Master | <p><u>The Speed Reduction.</u> Is the Master on the bridge? Has one of the speed reduction methods been chosen and commenced in appropriate time?</p> |
| <input type="checkbox"/> | Master | <p><u>Direction / strength of wind and current.</u> Are there any other vessels at anchor to indicate tide / wind? If the anchorage is empty with a strong current, do you know the direction and the rate of the current?</p> |
| <input type="checkbox"/> | Master | <p><u>Weather.</u> Is the weather / tide onshore?
 Is the wind less than 28 knots and current less than 3 knots?
 <i>(There are Classification Society limits).</i></p> |
| <input type="checkbox"/> | Master | <p><u>The Low Speed Manoeuvring.</u> Is the tidal stream and force of the wind when manoeuvring at low speed taken under consideration?
 Is there a clear, safe passage and clear of the fairway and dangers?</p> |
| <input type="checkbox"/> | Master | <p><u>Need for adequate sea room particularly to seaward.</u>
 Is there enough room to turn the vessel of 180 degrees / 360 degrees?</p> |
| <input type="checkbox"/> | Master | <p><u>Dangers.</u> Is the nearest grounding line or the danger placed more than one mile away from the planned anchor dropping position?</p> |

Master **Depth of water, type of seabed and scope of anchor cable required.** Is the depth less than 82 metres absolute minimum?
(*This is the class limit*). If depth is more than 30 metres, than walk back the anchor. Is the bed suitable? Not rock or coral?

O.O.W. **The Anchor Lights / Shapes / Sound Signalling Apparatus.** Are the anchor lights / shapes and sound signalling apparatus ready for use?

O.O.W. **Reporting.** Has the anchor position of the vessel been reported to the port authority after dropping an anchor?

Place:

Date:

Officer on Watch

Master

.....

.....

While at anchor, the OOW should:

- Vessel's Position:** Determine and plot the vessel's position on the appropriate chart as practicable
- Position Check:** When circumstances permit, check at sufficiently frequent intervals whether the vessel is remaining securely at anchor by taking bearings of fixed navigation marks or readily identifiable shore objects
- Look-out:** Ensure that proper look-out is maintained
- Inspection Rounds:** Ensure that inspection rounds of the vessel are made periodically
- Weather / State of the Sea:** Observe meteorological and tidal conditions and the state of the sea
- Dragging the Anchor:** Notify the Master and undertake all necessary measures if the vessel drags anchor
- Readiness of the Main Engines:** Ensure that the state of readiness of the main engines and other machinery is in accordance with the Master's instructions
- Visibility:** If visibility deteriorates, notify the Master
- Lights / Shapes / Sound Signals:** Ensure that the vessel exhibits the appropriate lights and shapes and the appropriate sound signals are made in accordance with all applicable regulations
- Environment:** Take measures to protect the environment from pollution by the vessel and comply with applicable pollution regulations

Other Checks:

-
-
-

Officer on Watch

Place: _____

Date: _____

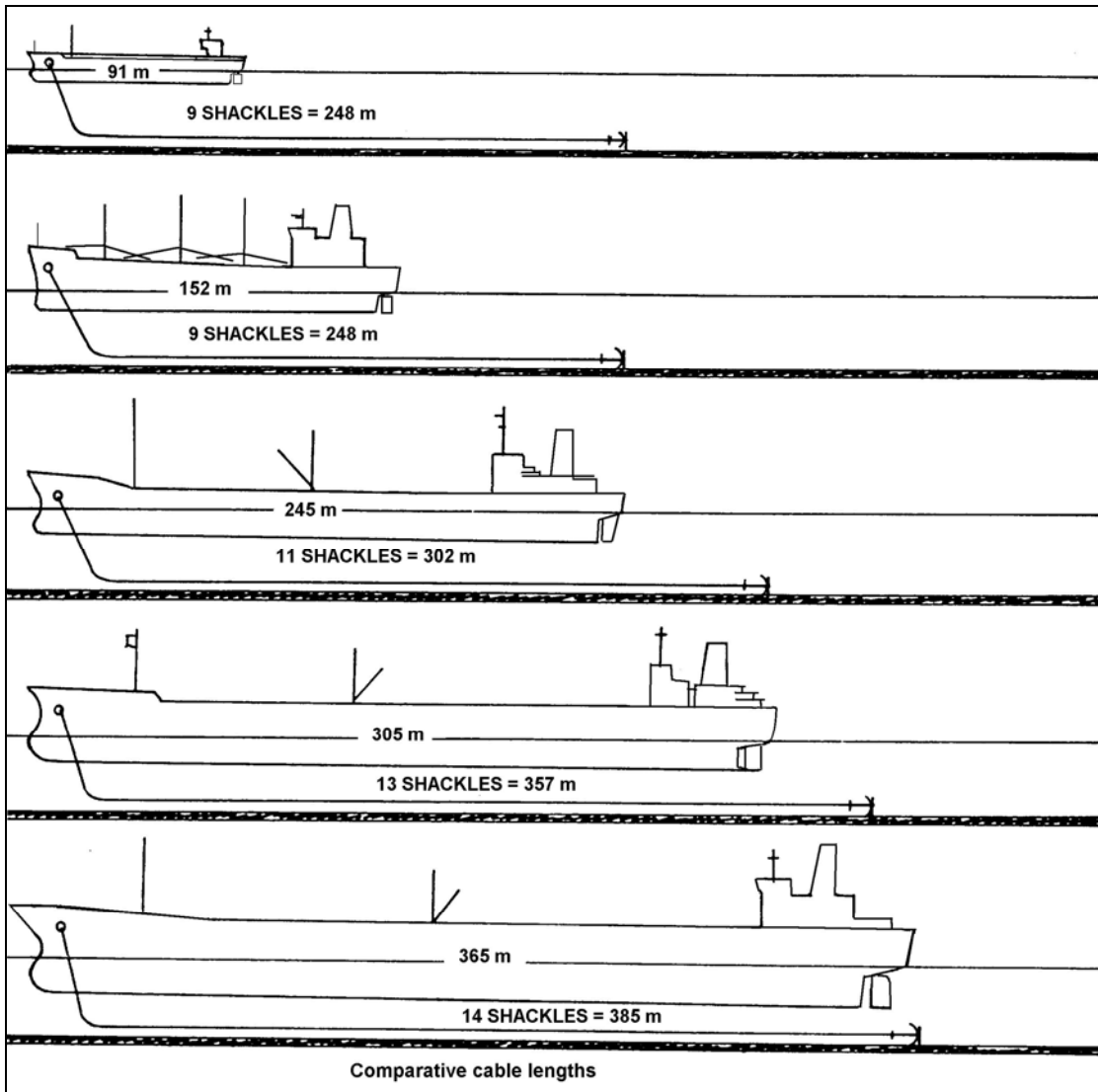

USE OF ANCHORS IN AN EMERGENCY

ALL SHIPS

STANDBY ANCHORS. ENSURE ANCHOR PARTY HAVE CLEAR INSTRUCTIONS BEFORE LETTING GO ANCHORS

IF NATURE OF EMERGENCY PERMITS OR IF TIME, REDUCE SPEED TO MINIMUM

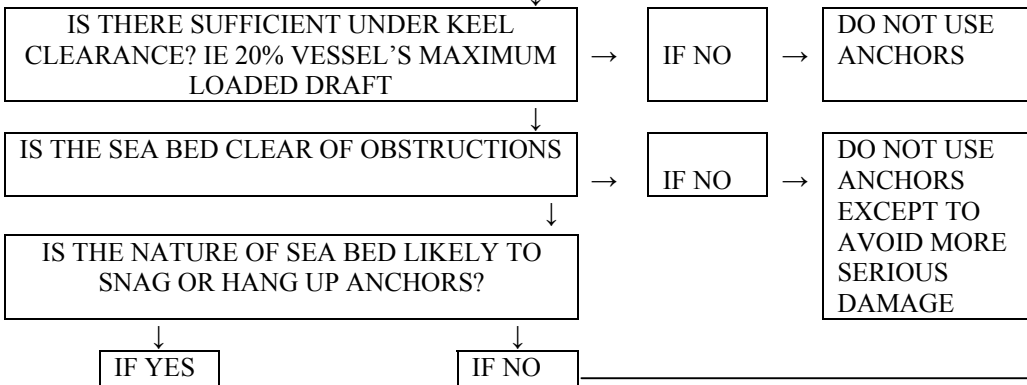

SHIPS UNDER 30,000 DWT	SHIPS 30,000/60,000 DWT	SHIPS OVER 60,000 DWT
LET GO BOTH ANCHORS ON THE TURN, CHECKING & VEERING UNTIL VESSEL STOP	ONLY USE ANCHORS IF SPEED BELOW 4 KNOTS	ONLY USE ANCHORS IF SPEED BELOW 2 KNOTS
	TRY DRAGGING WITH BOTH ANCHORS 2 X DEPTH	TRY DRAGGING BOTH ANCHORS 2 X DEPTH
	IF UNABLE TO HOLD VEER & CHECK CABLE IF POSSIBLE	IF UNABLE TO HOLD VEER CABLE
	SOME RISK OF LOSING ANCHORS	PROBABLE LOSS OF BOTH ANCHORS
	ONLY USE TO PREVENT SERIOUS DAMAGE	DANGER TO ANCHOR PARTY, USE TO BE AVOIDED

SHIPS UNDER 30,000 DWT	SHIPS 30,000/60,000 DWT	SHIPS OVER 60,000 DWT
MAX SPEED 8 KNOTS	MAX SPEED 6 KNOTS	MAX SPEED 3 KNOTS
LET GO BOTH ANCHORS, CHECK AT 2 X DEPTH, DRAG UNTIL STOPPED		
ONLY PUT OUTMORE CHAIN IF UNABLE TO PREVENT GROUNDING		

MAX. PERMISSIBLE SPEED OF LARGE VESSELS DURING ANCHORING

Conditions: 1 anchor dropped, speed when the anchor reaches the bottom, the anchor does not drag and the chain is not parted

DWT	49,000		65,000		90,000		190,000	
Loading Condition	<i>Fully Loaded</i>	<i>In Ballast</i>	<i>Fully Loaded</i>	<i>In Ballast</i>	<i>Fully Loaded</i>	<i>In Ballast</i>	<i>Fully Loaded</i>	<i>In Ballast</i>
<i>Main Engine stopped. Completely new chain with full breaking strength</i>	0.9	1.1	0.9	1.3	0.8	1.2	0.7	1.1
<i>Main Engine stopped. Chain with 60% breaking strength of new chain breaking strength only.</i>	0.8	1.1	0.8	1.2	0.7	1.2	0.6	1.0
<i>Full power given astern on the Main Engine before the anchor is dropped. Completely new chain with full breaking strength.</i>	3.9	6.1	3.9	5.4	3.6	5.1	2.9	4.1

References:

1. Behaviour and Handling of Ships, by Henry H. Hooyer, Cornell Maritime Press, 1983.
2. Bridge Procedures Guide, Third Edition 1988, International Chamber of Shipping. Whiterby Publishers, 1998.
3. Fremantle Pilots Operations File, 1998.
4. Guide to Port Entry 1999 – 2000 originally devised by: Colin Pielow, Shipping Guides Ltd, Nautical Advisers and Publishers, 1999.
5. Inzynieria Ruchu Morskiego,(in polish) by Capt. Stanislaw Gucma, Okretownictwo i Zegluga, 2001
6. Nicholls's Seamanship and Nautical Knowledge, 27th Edition 1997, Brown, Son & Ferguson, Ltd., Glasgow.
7. Parana River Ports Guide, 2001, Rosario Pilots, Argentina.
8. Practical Ship Handling, by Malcom C. Armstrong, Second Edition 1994. Brown, Son & Ferguson, Ltd., Glasgow.
9. Seaway Handbook, 2001 Edition, The St. Lawrence Seaway Management Corporation.
10. Shiphandling for the Mariner, by Daniel H. MacElrevey, Cornell Maritime Press, Third Edition 1995.
11. The Evasion of The Tropical Cyclones, by Capt. F.P.A. Jamin, 1986. The Nederland's Federation of Master Mariners and The Royal College Zeemanshoop.
12. The Nautical Institute on Command, A Practical Guide, The Nautical Institute, Second Edition, 2000.
13. The Nautical Institute on Pilotage and Shiphandling, The Nautical Institute 1990
14. The Shiphandler's Guide, The Nautical Institute, Second Edition, 2000.
15. Wiedza o manewrowaniu statkami morskimi,(in polish) by Capt. Aleksander Nowicki, 2nd Edition, Trademar Gdynia, 1999.